

S 91 ...T

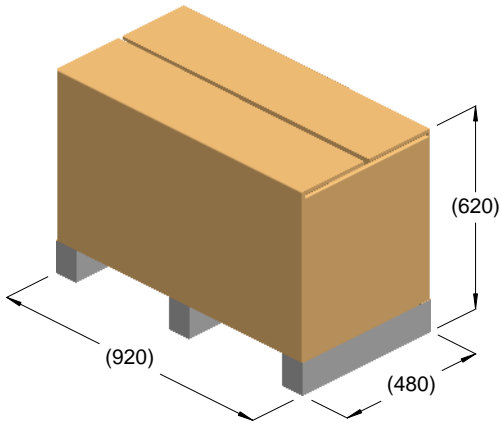

kg = 156
m³ = 0.27

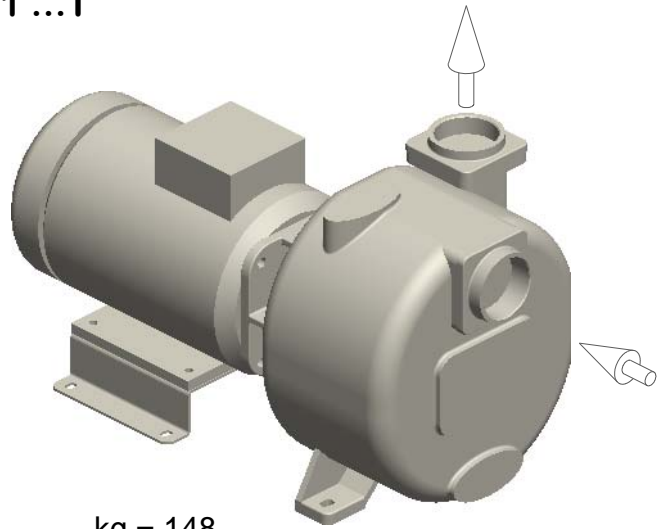

kg = 148

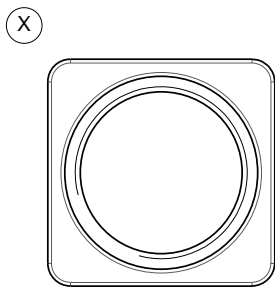
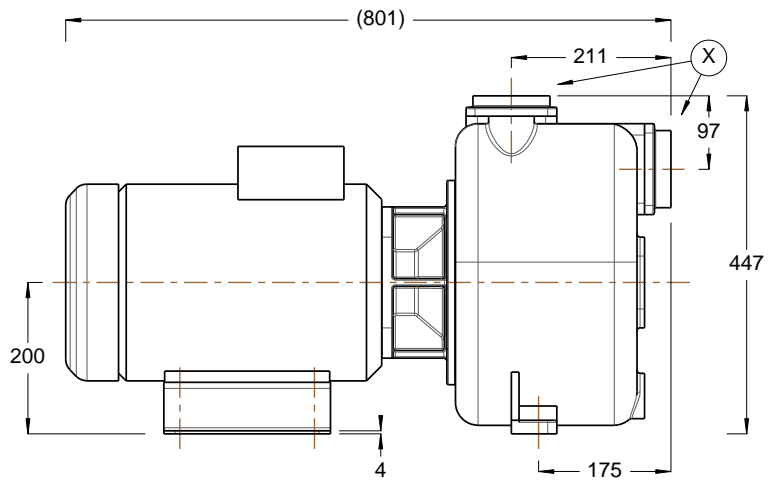
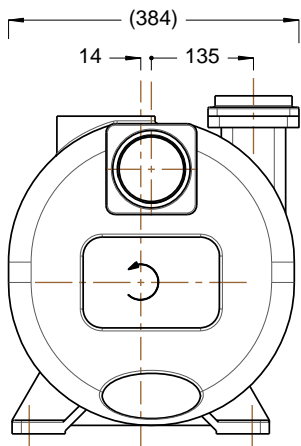

R3" BSP

