

S 91 ...T+F

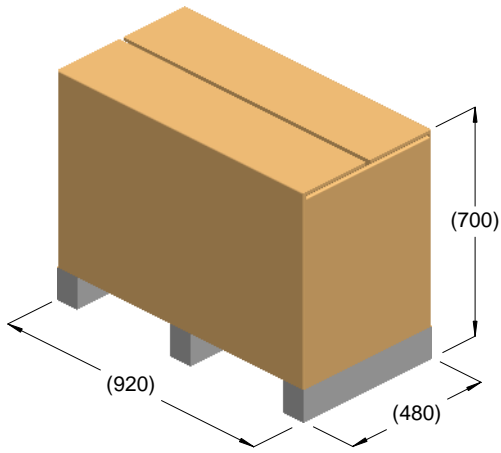

kg = 173
m³ = 0.31

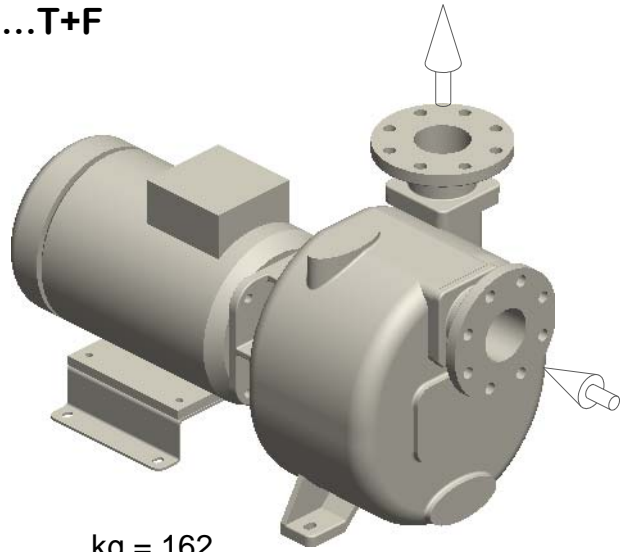

kg = 162

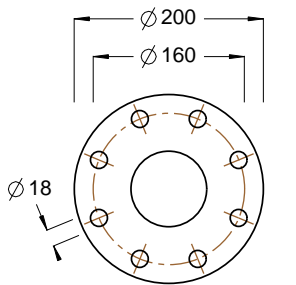
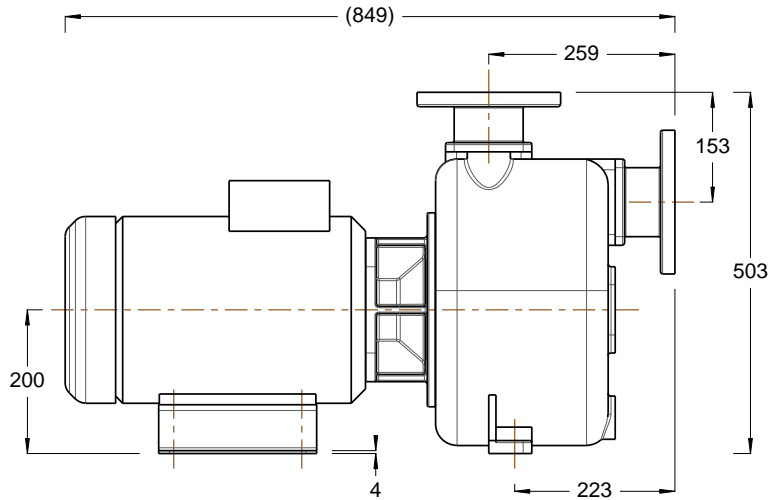
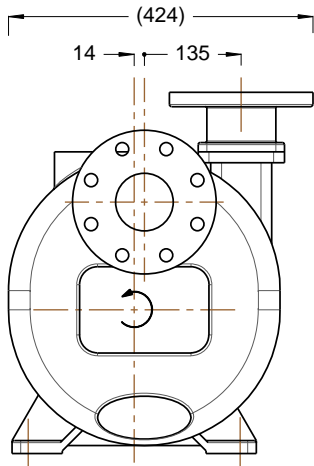

DN80 PN16 / ASA125 3"

