

S 88 ...T

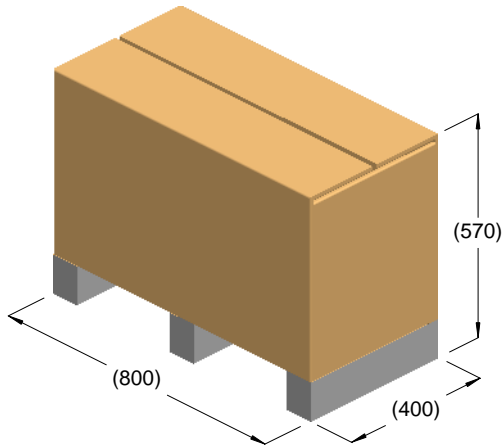

kg = 139
m³ = 0.18

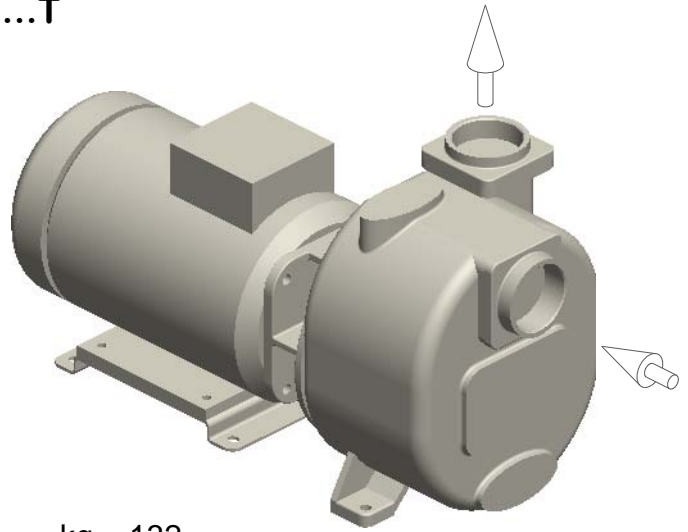

kg = 132

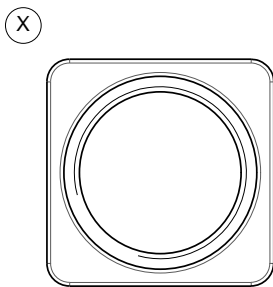
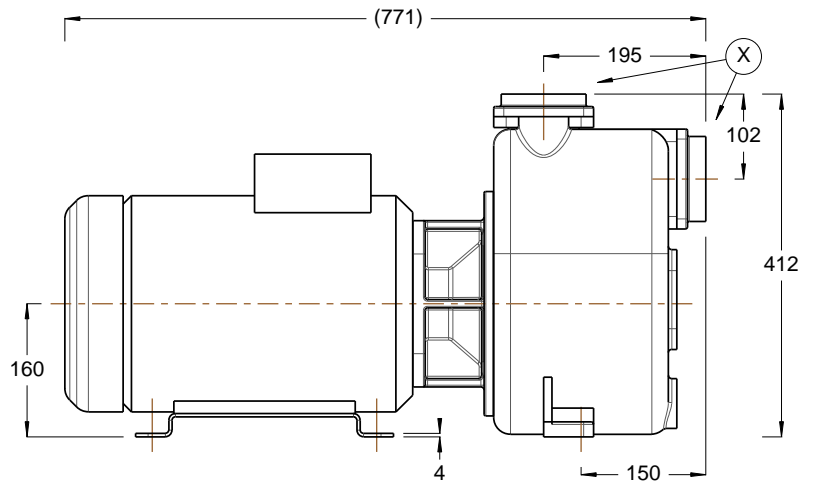
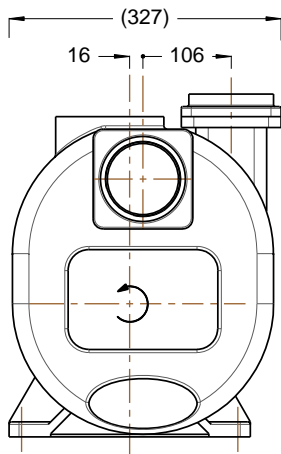

R3" BSP

