

S 85 ...T

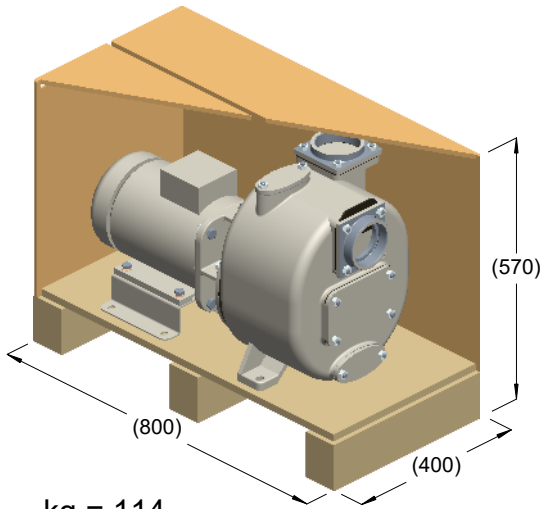

kg = 114
m³ = 0.18

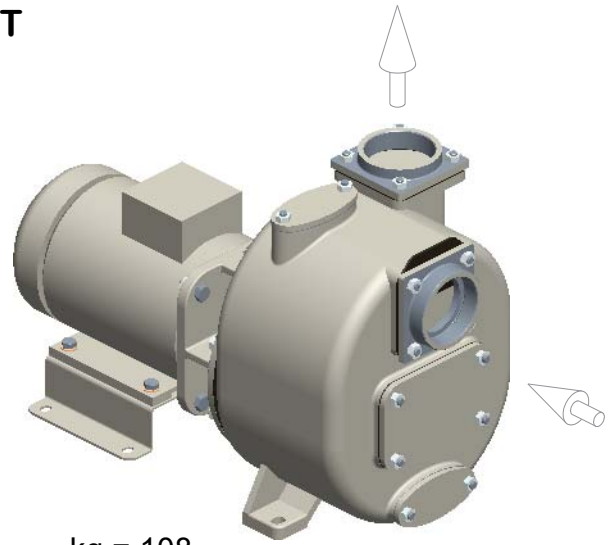

kg = 108

