

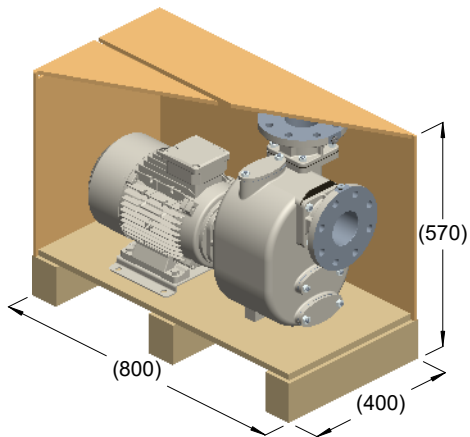

S 83 ...T+F

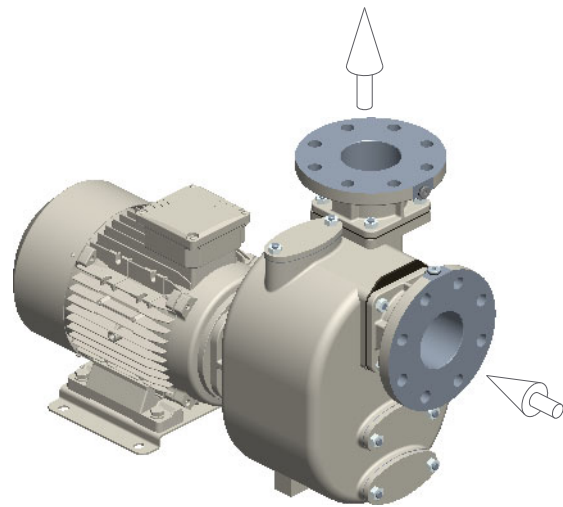

kg = 104
m³ = 0.18



kg = 97

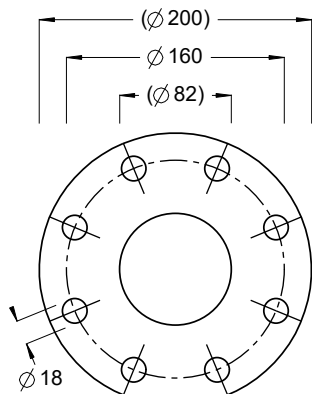
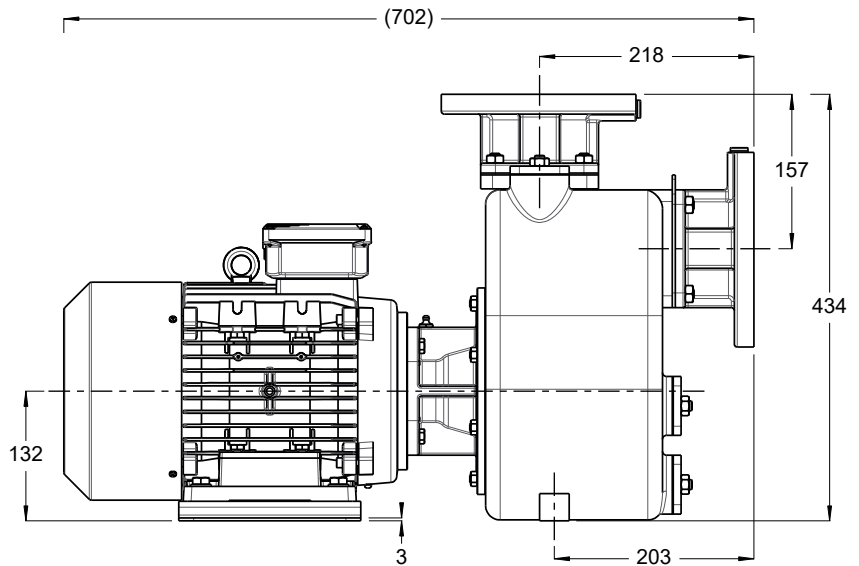
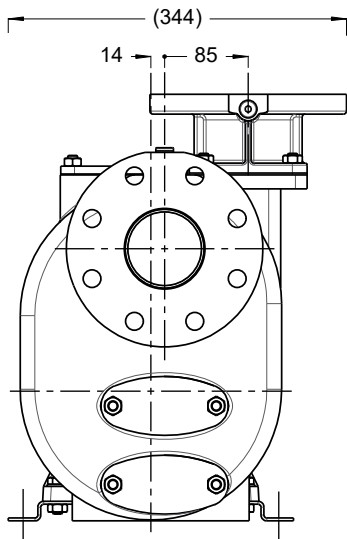

ISO DN80 PN16

