

S 83 ...T+F

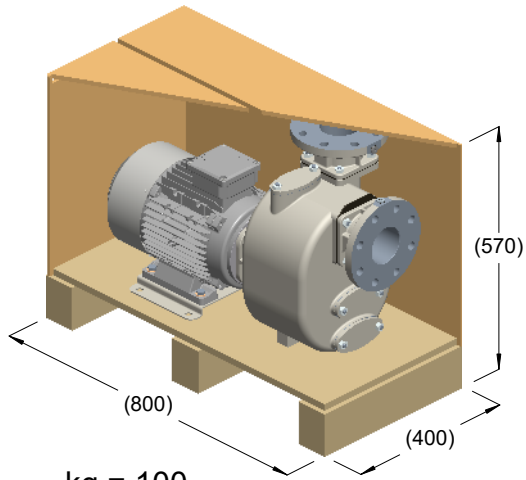

kg = 100
m³ = 0.18

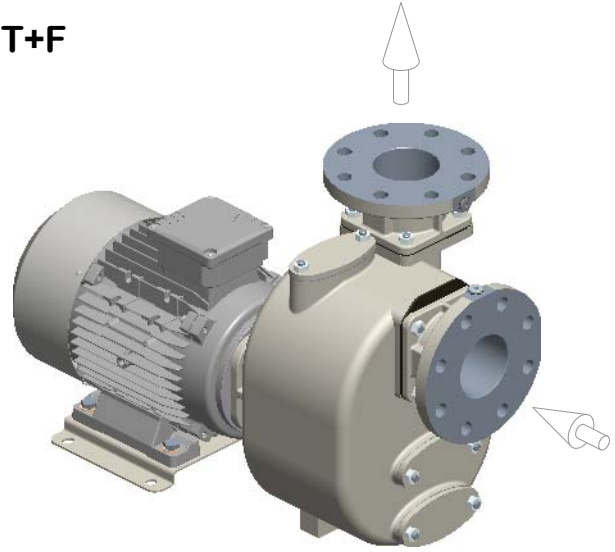

kg = 94

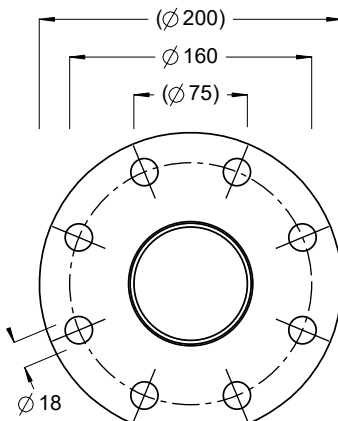
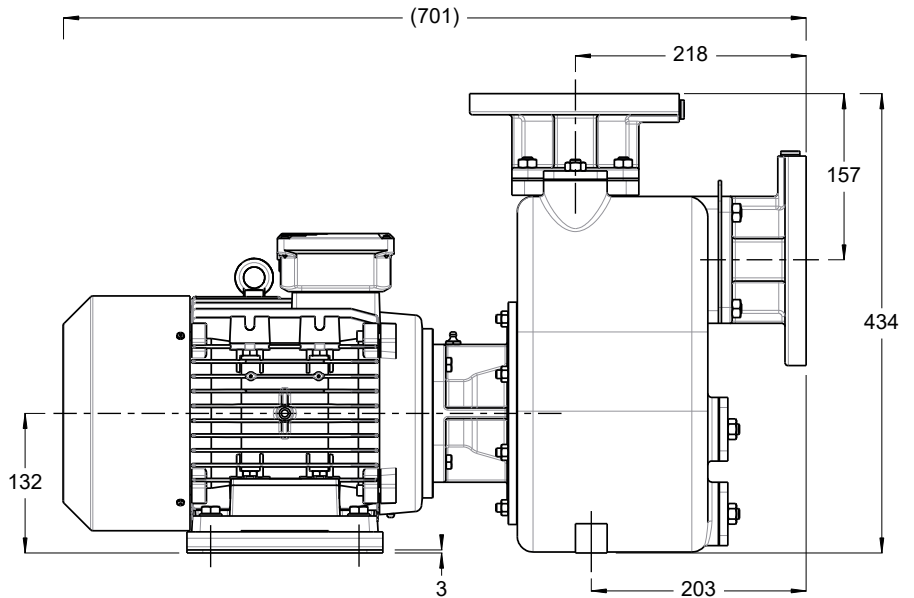
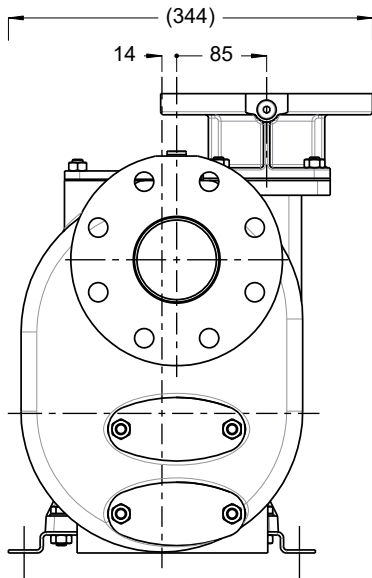

ISO DN80 PN16

