

S 82 K..T

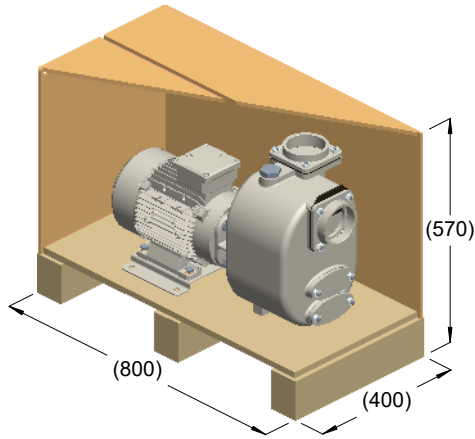

kg = 85
m³ = 0.18

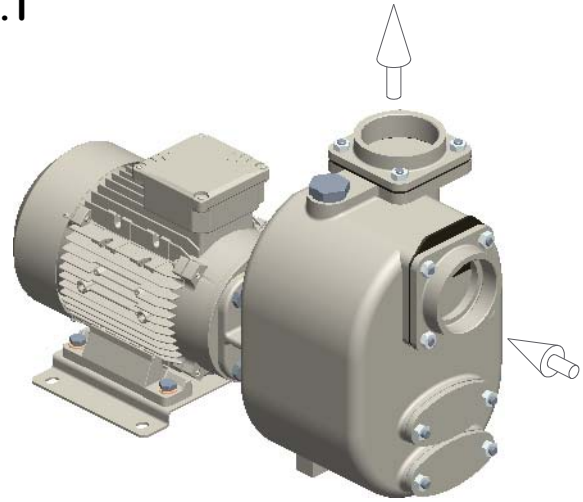

kg = 78

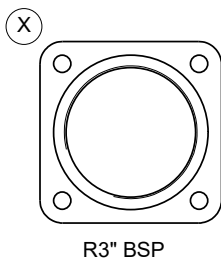
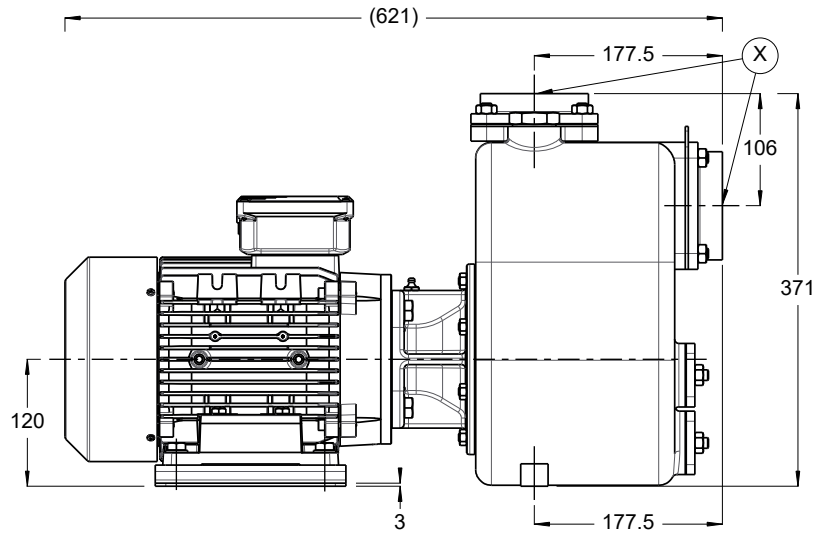
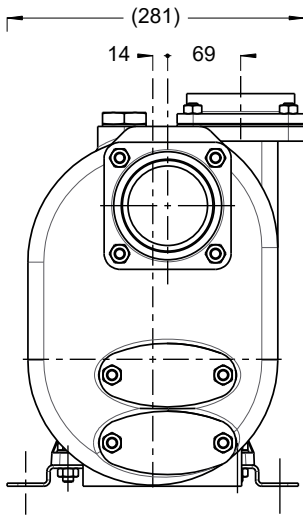

R3" BSP

