

S 80 ...T

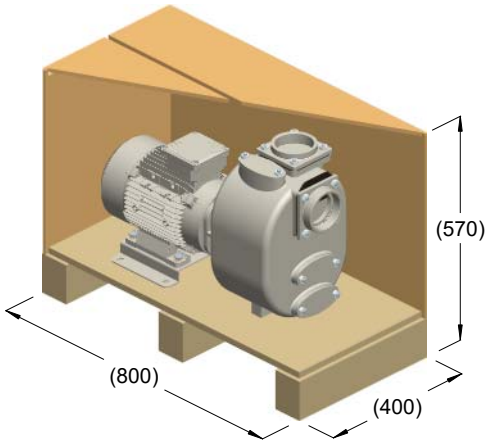

kg = 81
m³ = 0.18

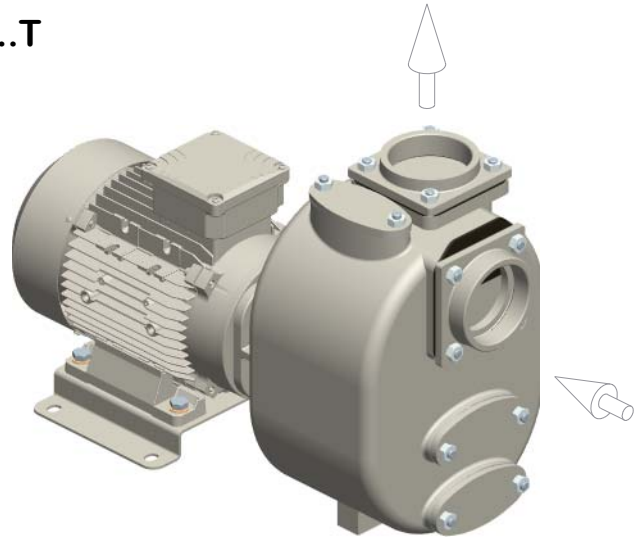

kg = 75

