

S 80 ...T+F

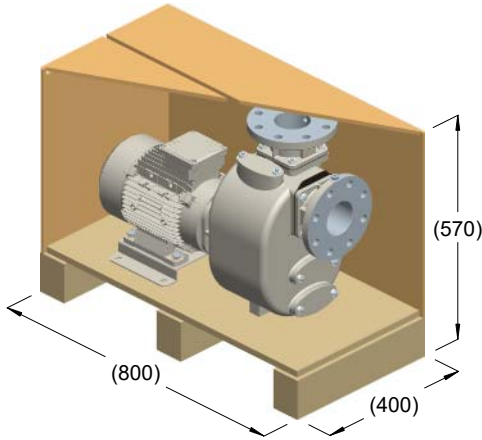

kg = 90
m³ = 0.18

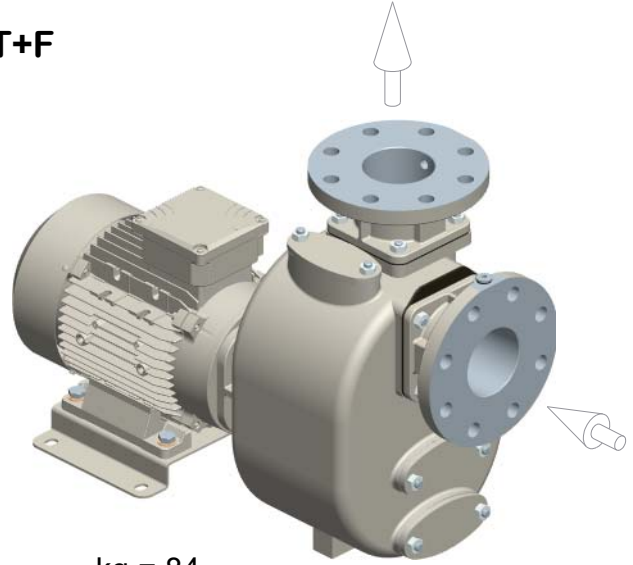

kg = 84

