

**S 69 K..T**

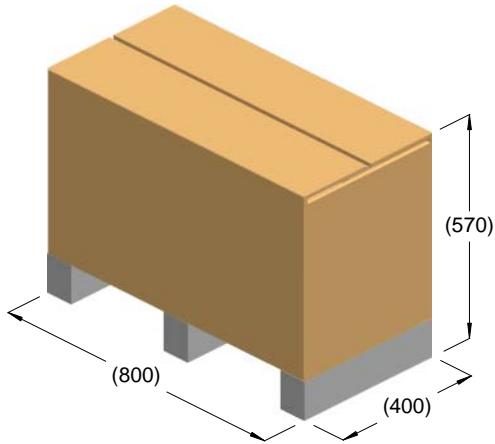

kg = 122  
m<sup>3</sup> = 0.18

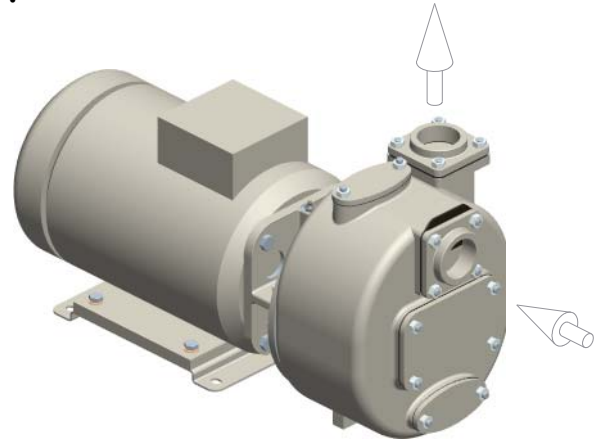

kg = 115

