

S 69 K..T+F

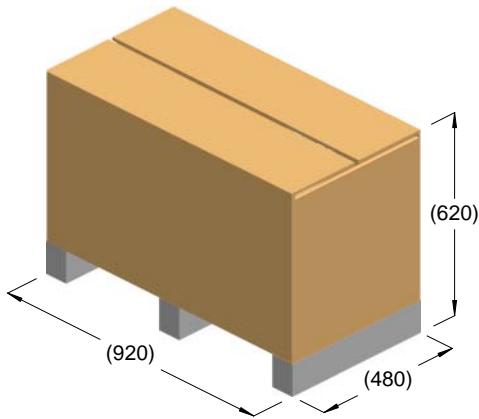

kg = 126
m³ = 0.27

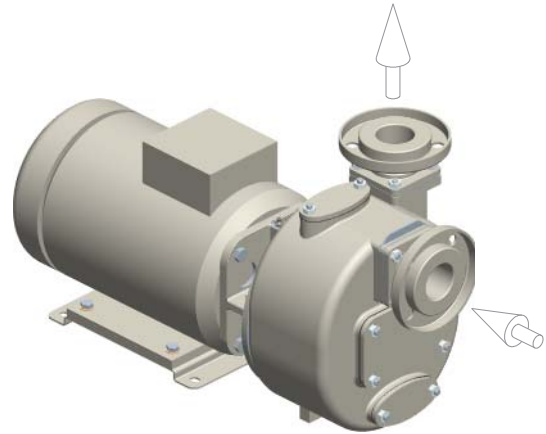

kg = 118

