

S 65 ...T

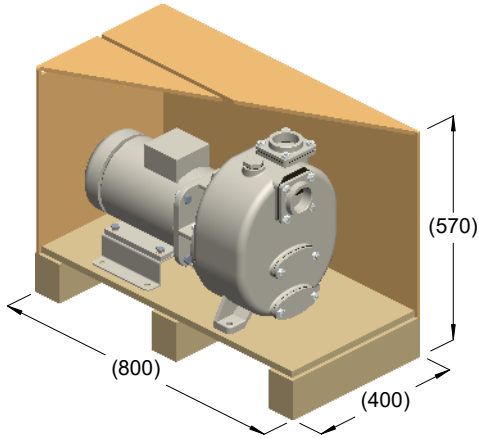

kg = 85
m³ = 0.18

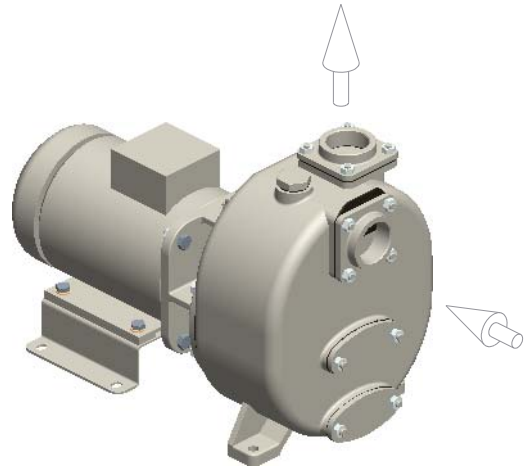

kg = 79

