

S 65 ...T+F

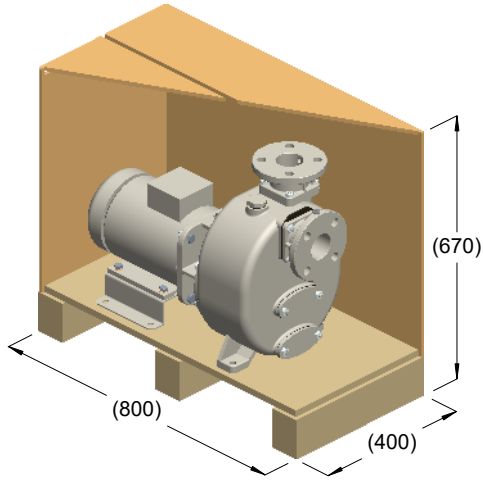

kg = 92
m³ = 0.21

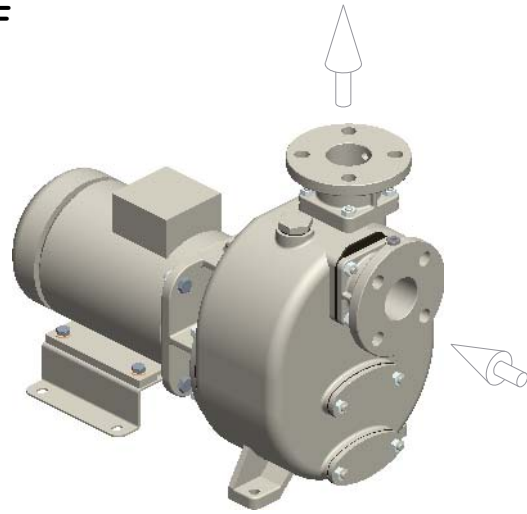

kg = 85

