

**S 63 ...T**

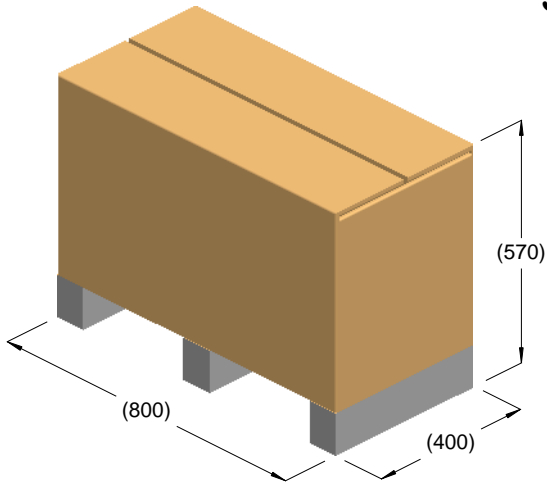

kg = 78  
m<sup>3</sup> = 0.18

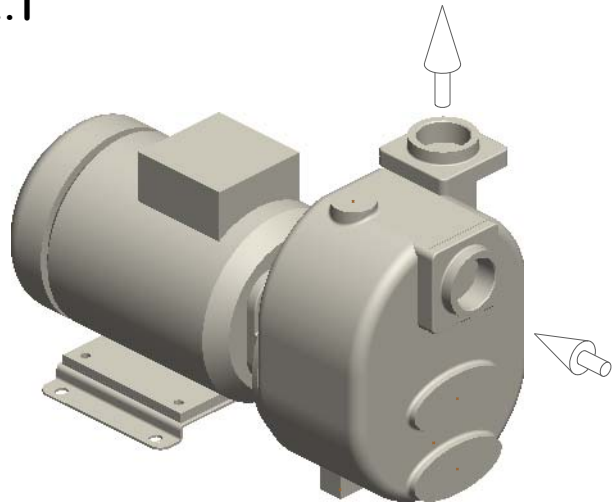

kg = 71

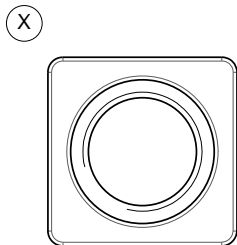
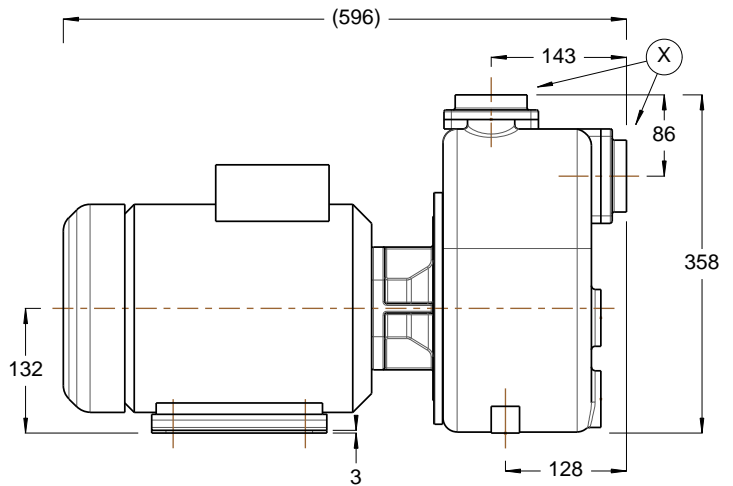
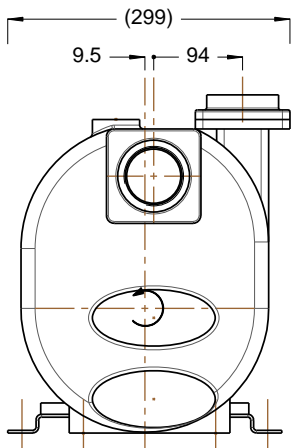

R2" BSP

