

**S 63 ...T+F**

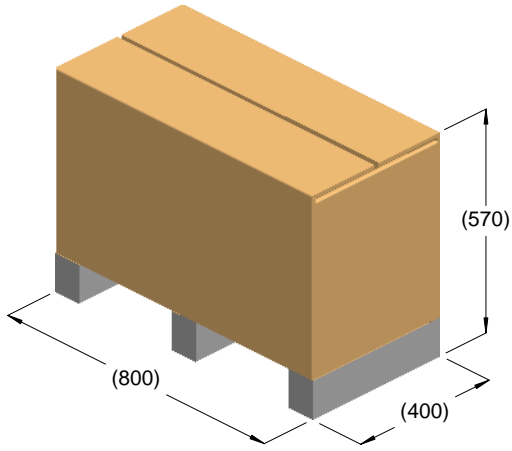

kg = 84  
m<sup>3</sup> = 0.18

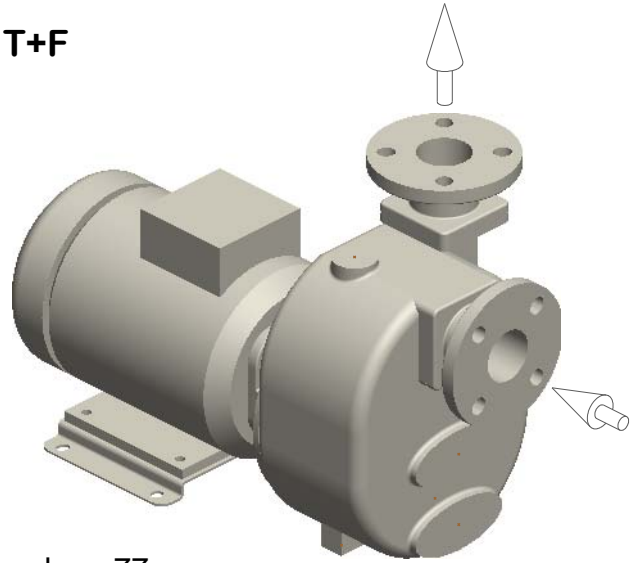

kg = 77

