

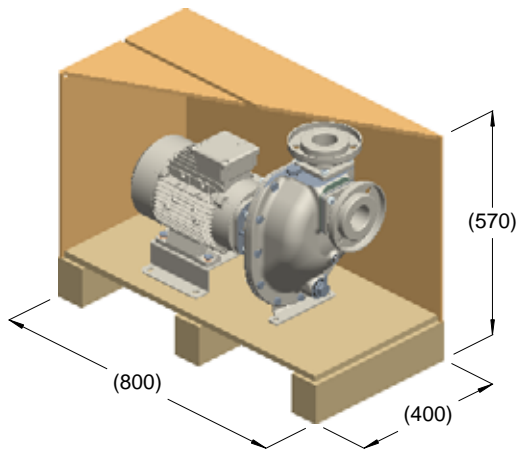

S 62 K..T+F

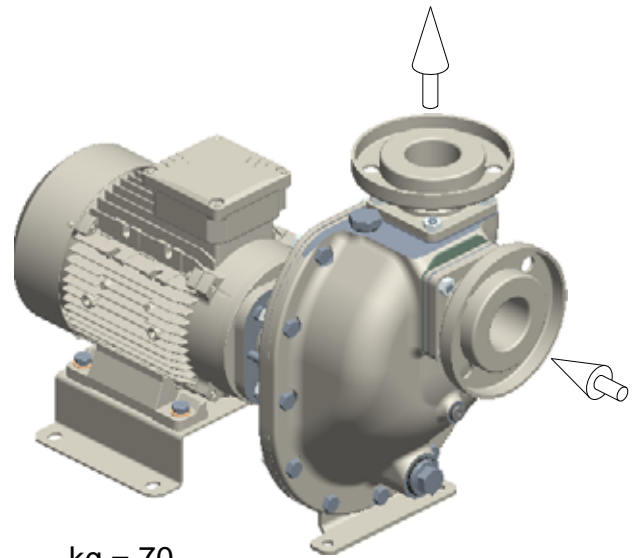

kg = 77
m³ = 0.18



kg = 70

