

S 61 K..T

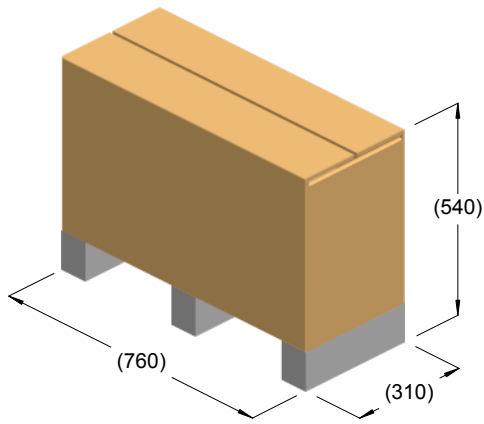

kg = 78
m³ = 0.13

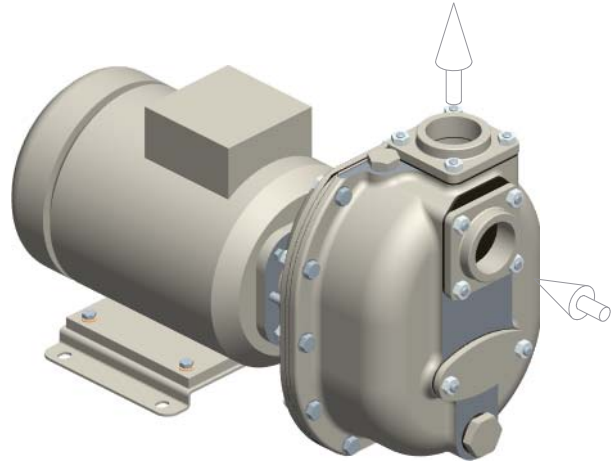

kg = 72

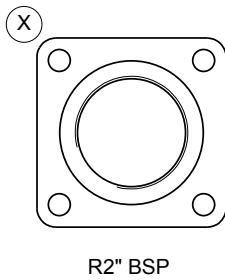
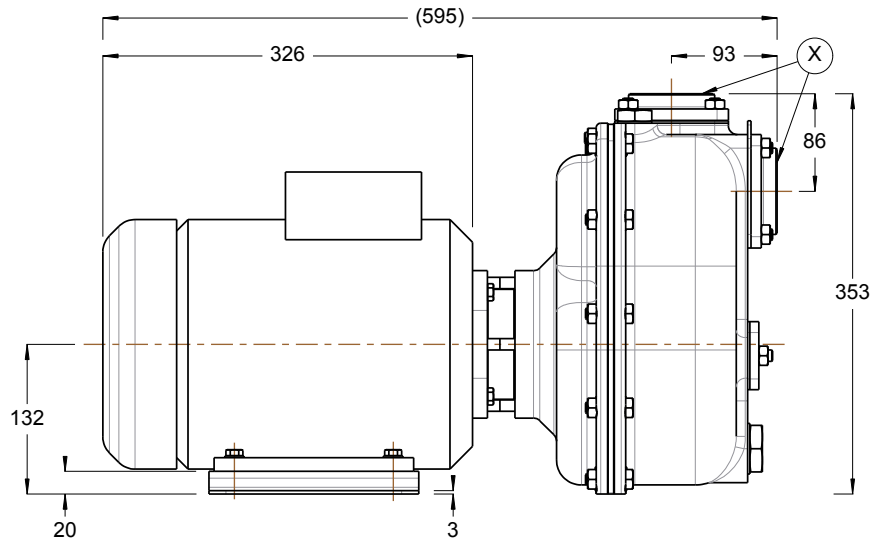
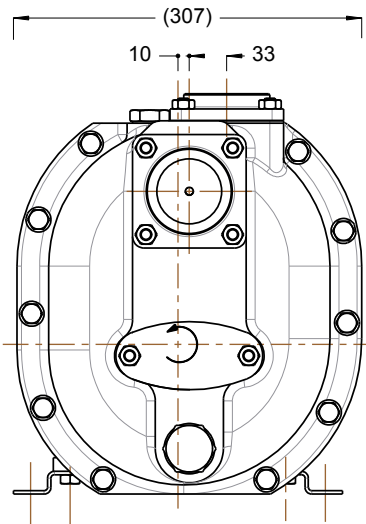

R2" BSP

