

S 61 K..T+F

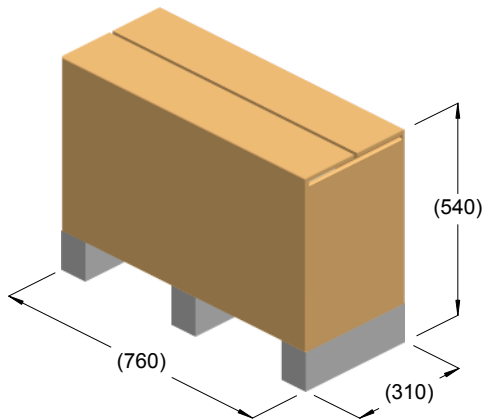

kg = 81
m³ = 0.13

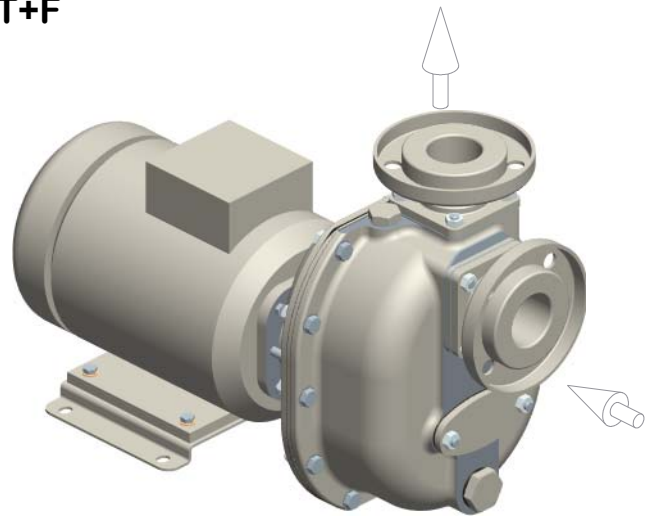

kg = 75

