

S 60 ...T

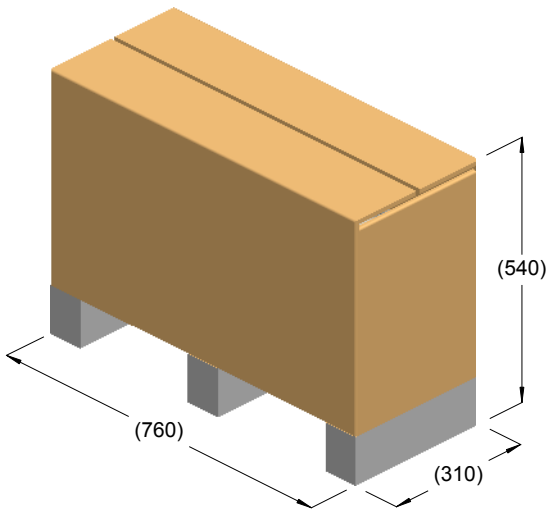

kg = 70
m³ = 0.13

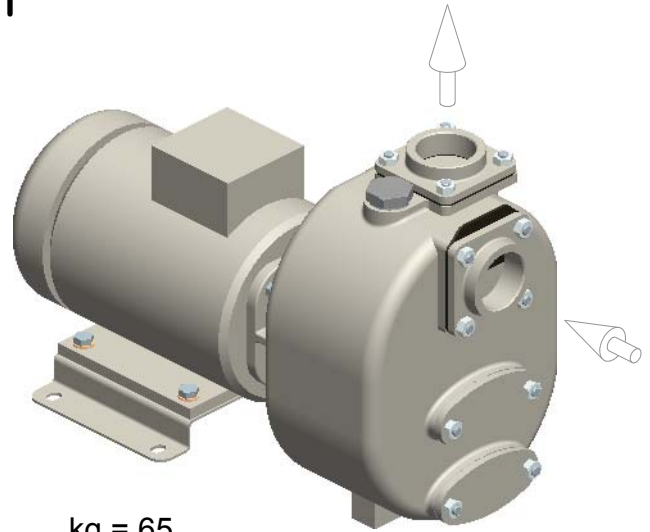

kg = 65

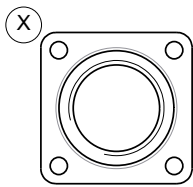
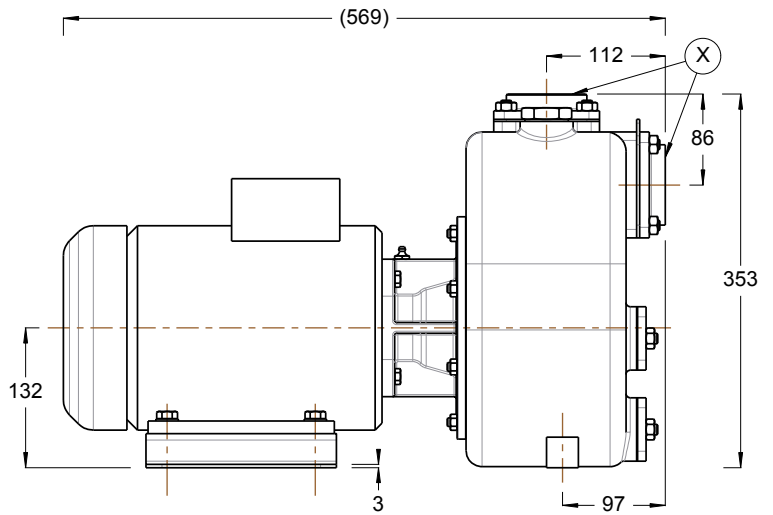
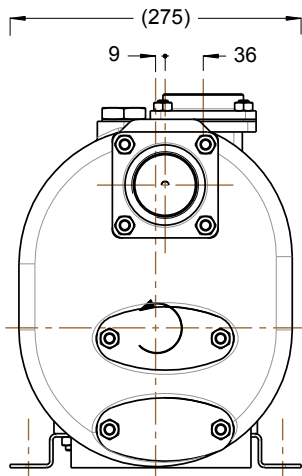

R2" BSP

