

S 51 K..T+F

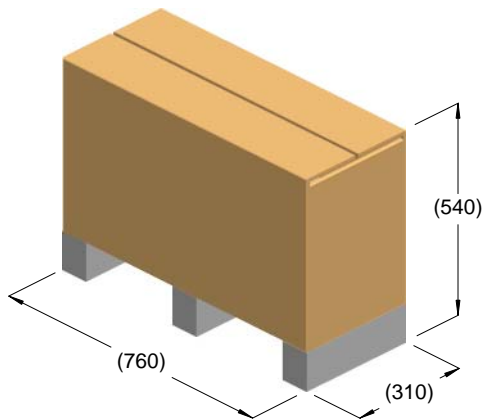

kg = 53
m³ = 0.13

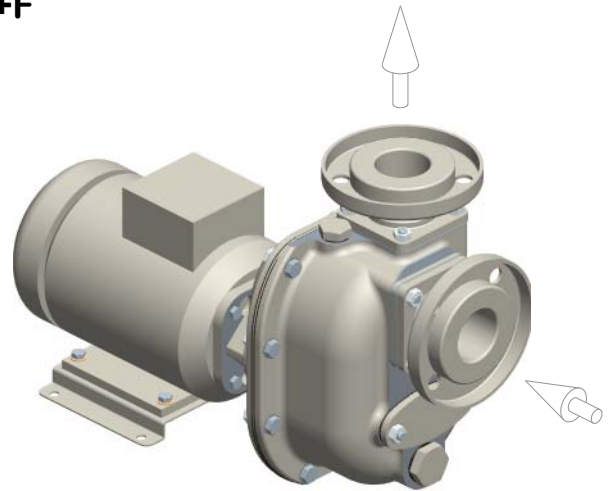

kg = 48

