

S 50 ...T

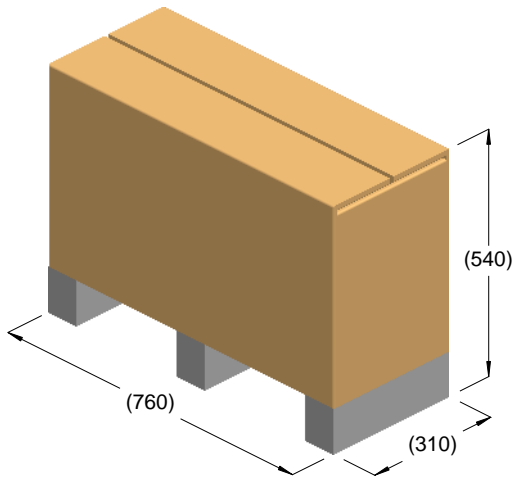

kg = 42
m³ = 0.13

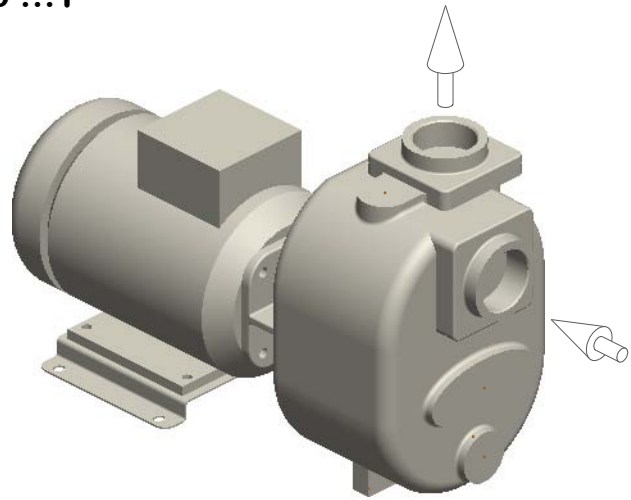

kg = 36

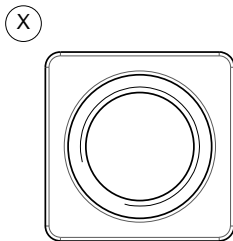
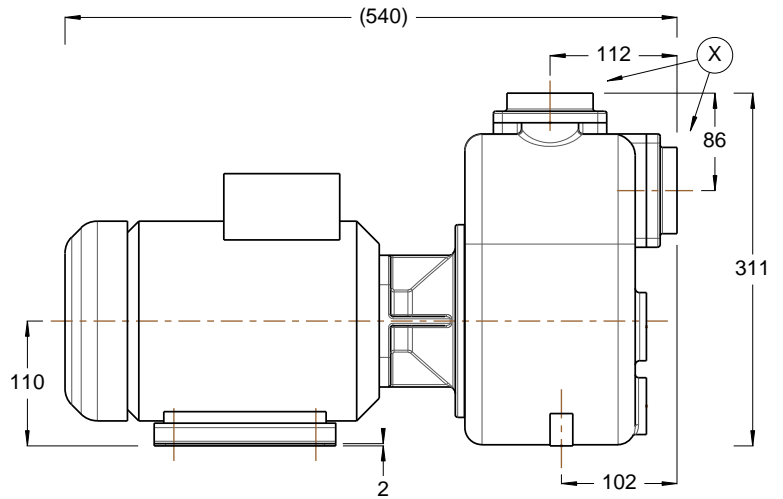
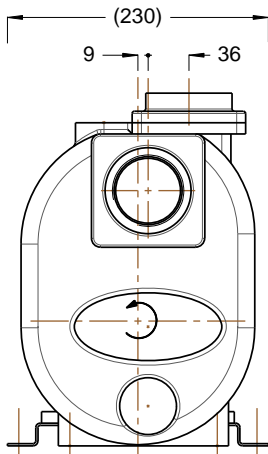

R2" BSP

