

S 50 ...T+F

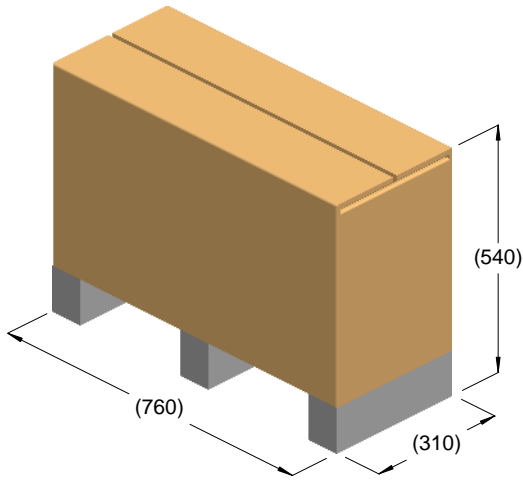

kg = 49
m³ = 0.13

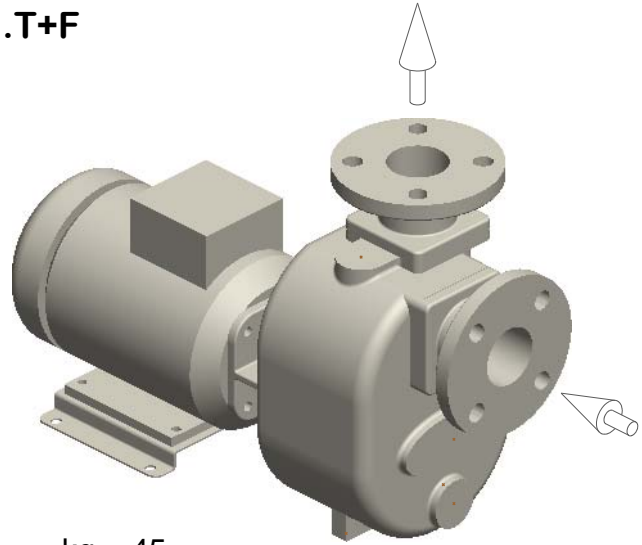

kg = 45

