

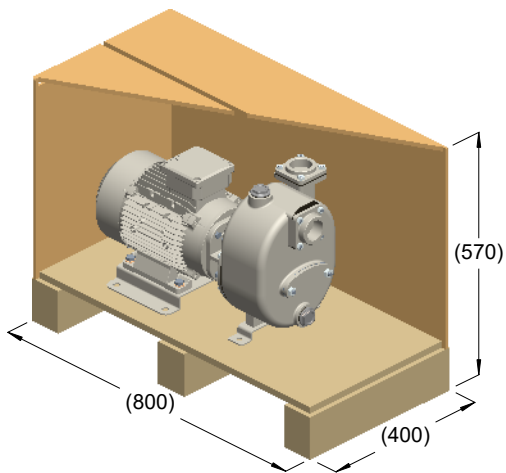

S 48 ...T

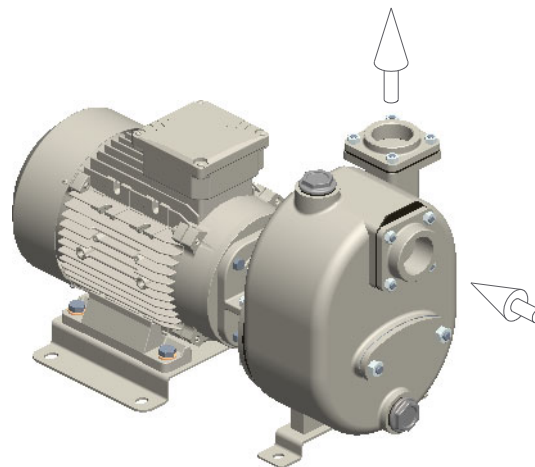

kg = 66
m³ = 0.18



kg = 59

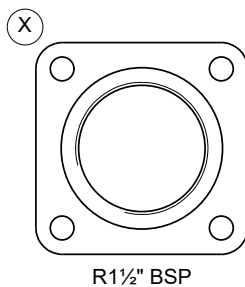
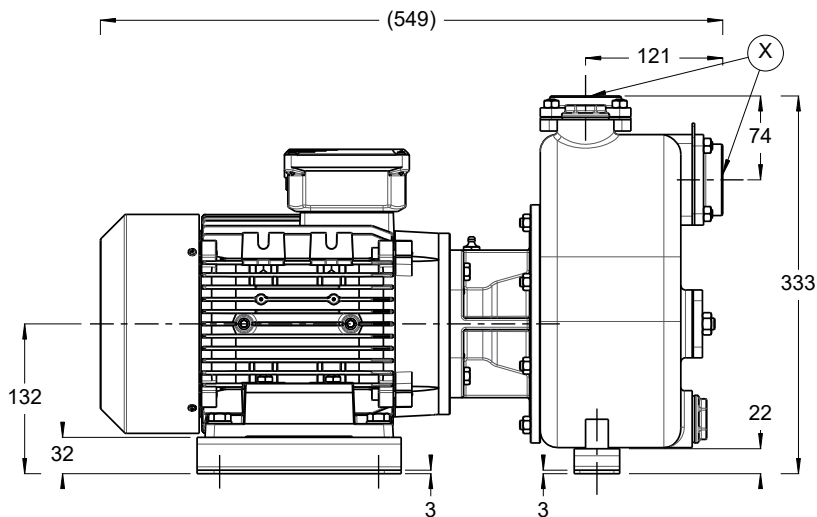
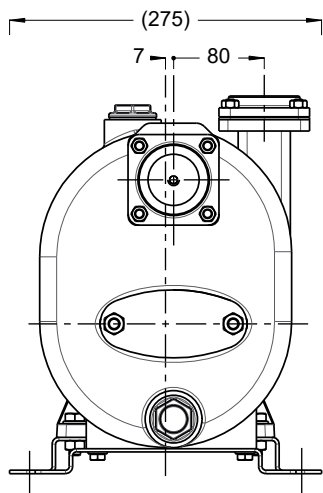

R1½" BSP

