

S 46 K..T+F

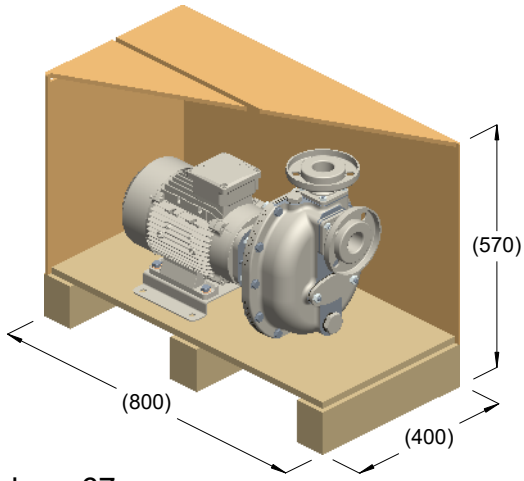

kg = 67
m³ = 0.18

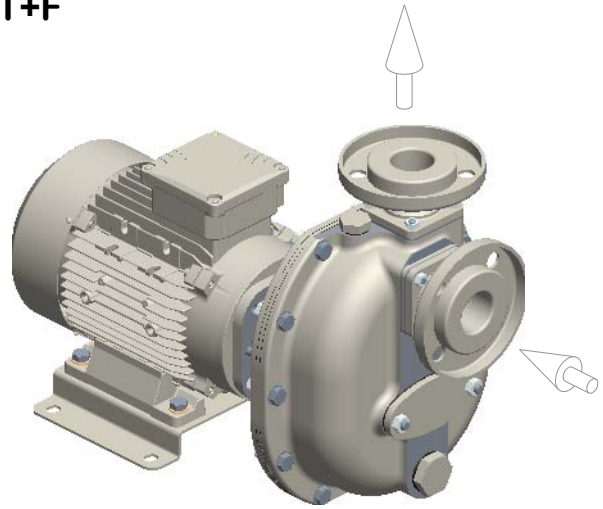

kg = 60

