

S 45 ...T

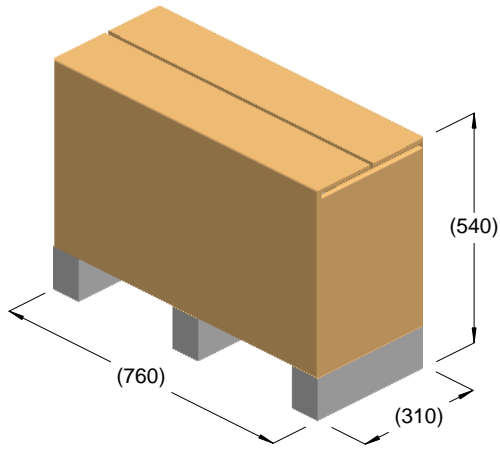

kg = 48
m³ = 0.13

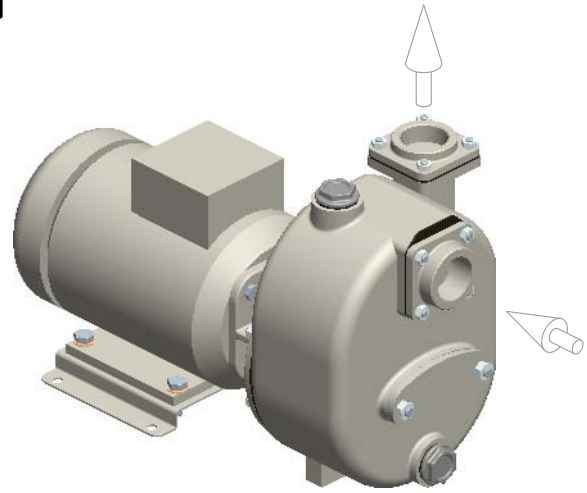

kg = 43

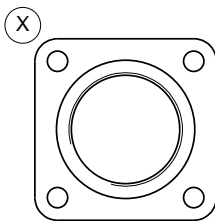
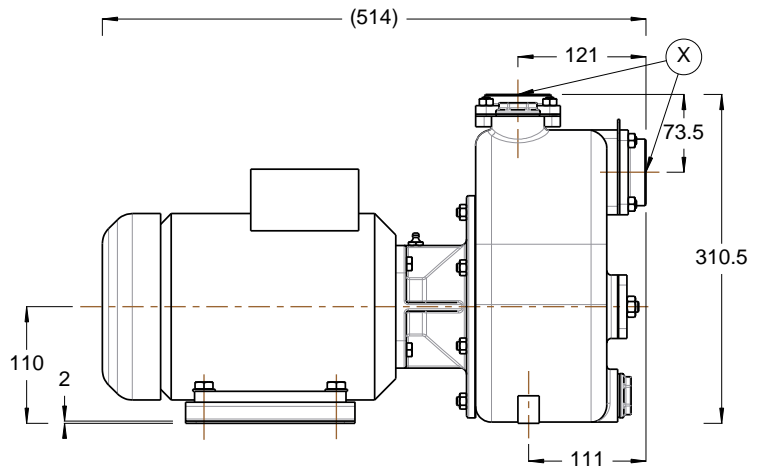
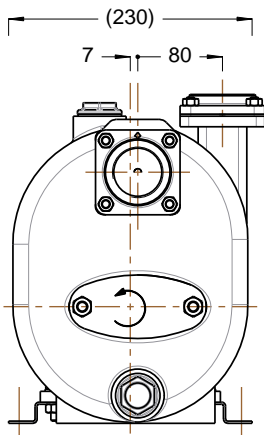

R 1½" BSP

