

S 45 ...T+F

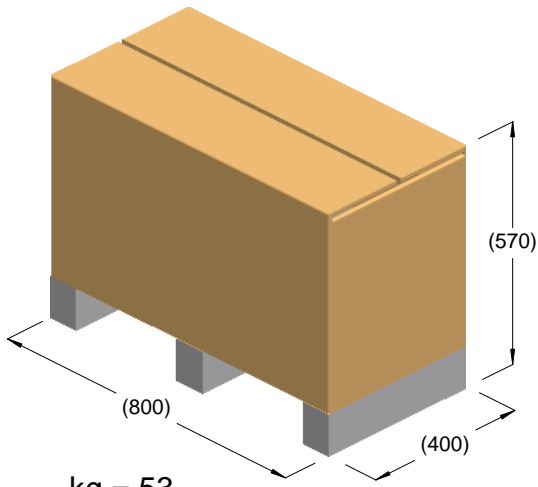

kg = 53
m³ = 0.18

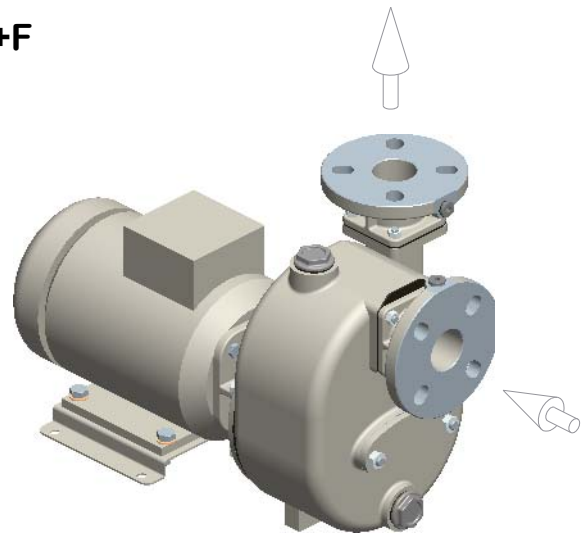

kg = 47

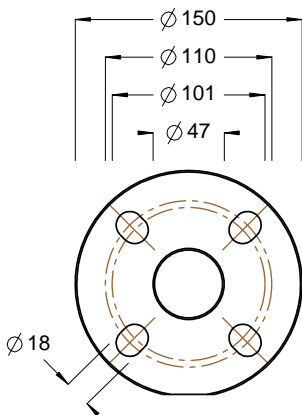
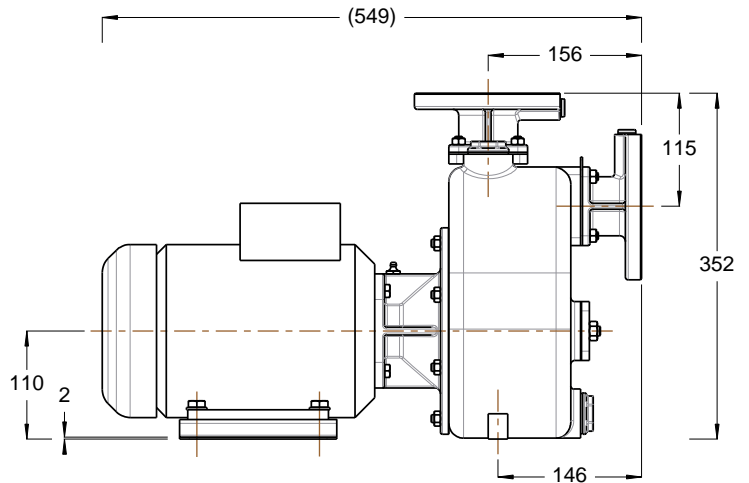
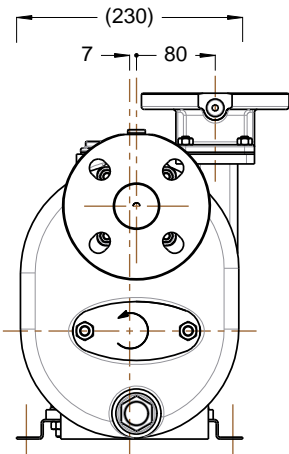

ISO DN40 PN16
ANSI 1/2" 125lb

