

S 41 K..T+F

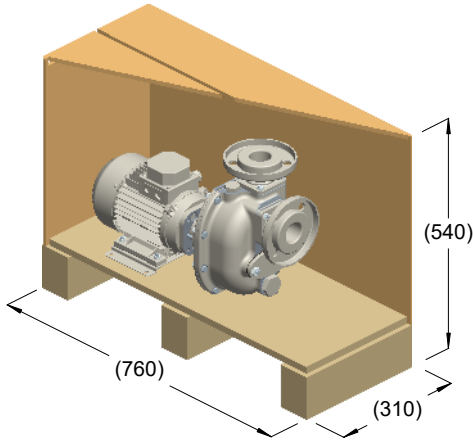

kg = 36
m³ = 0.13

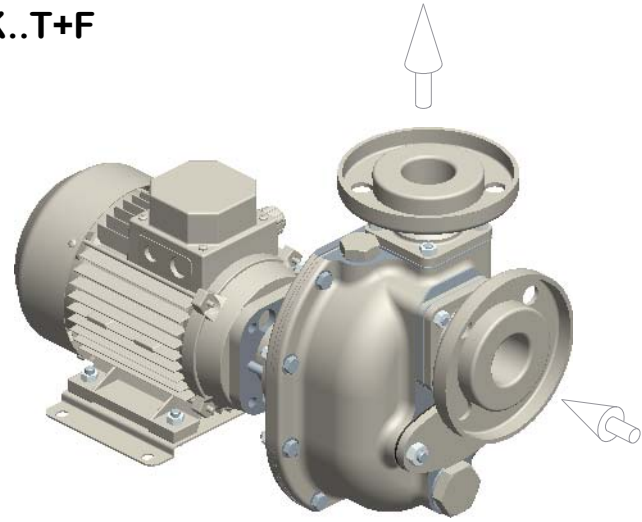

kg = 31

