

S 40 ...T+F

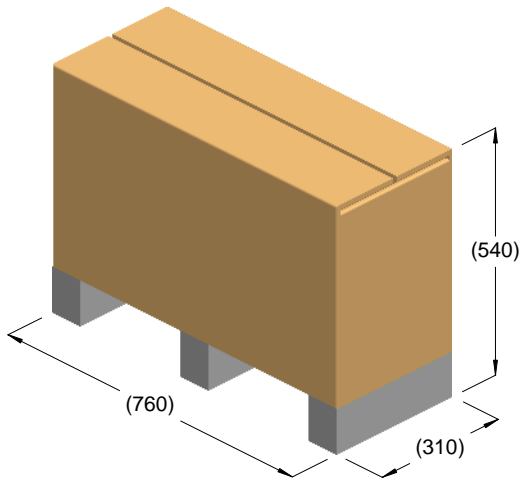

kg = 33
m³ = 0.13

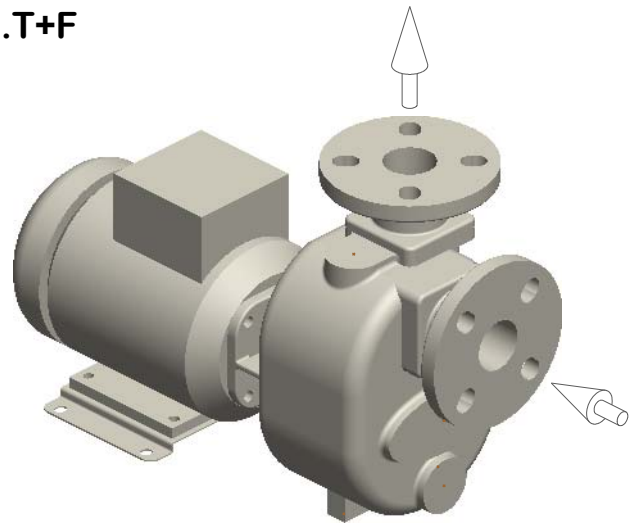

kg = 28

