

**S150 ...T+F**

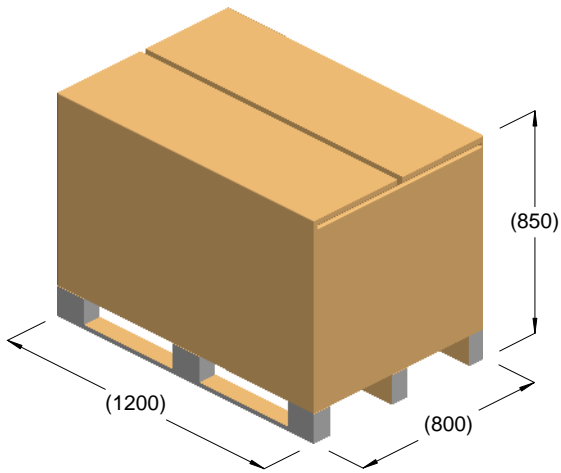

kg = 236  
m<sup>3</sup> = 0.82

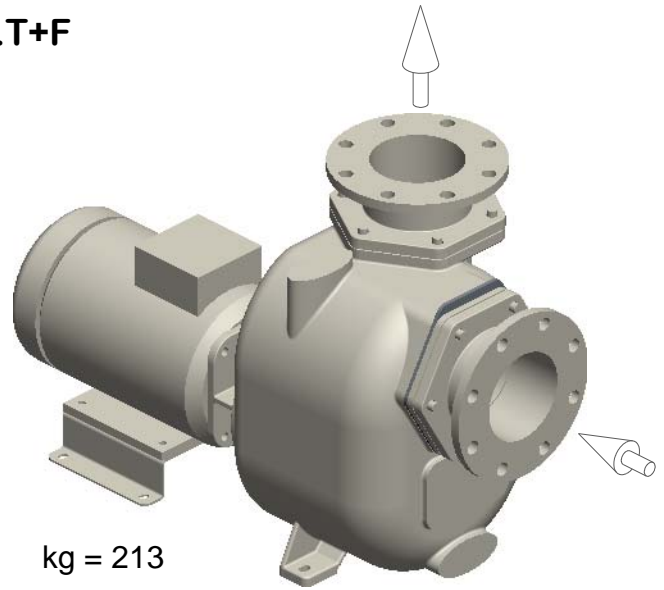

kg = 213

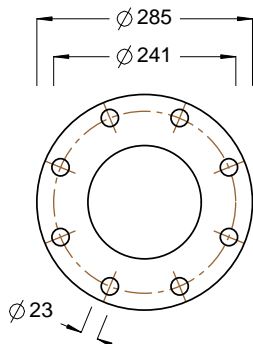
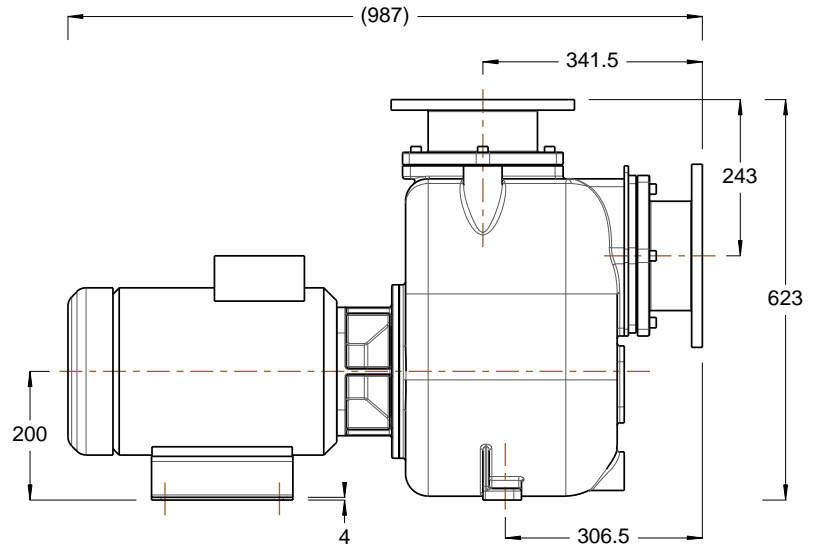
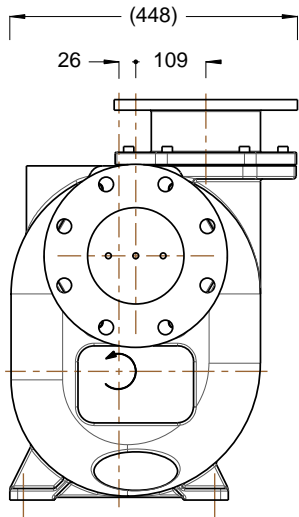

DN150 PN16 / ASA125 6"

