

S121 ...T

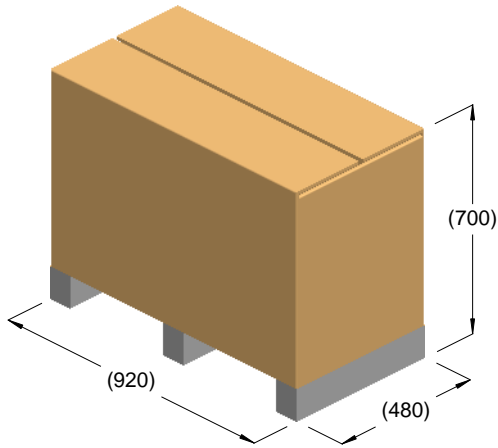

kg = 201
m³ = 0.31

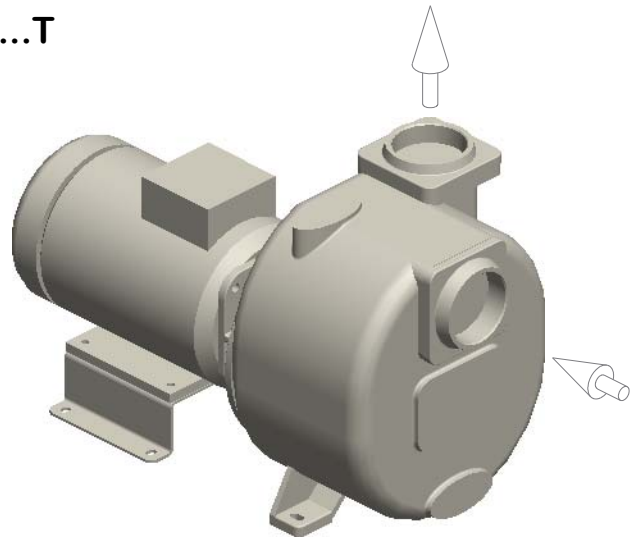

kg = 189

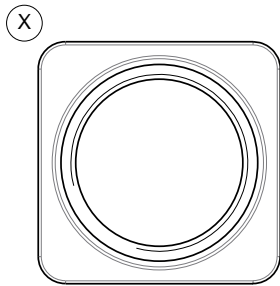
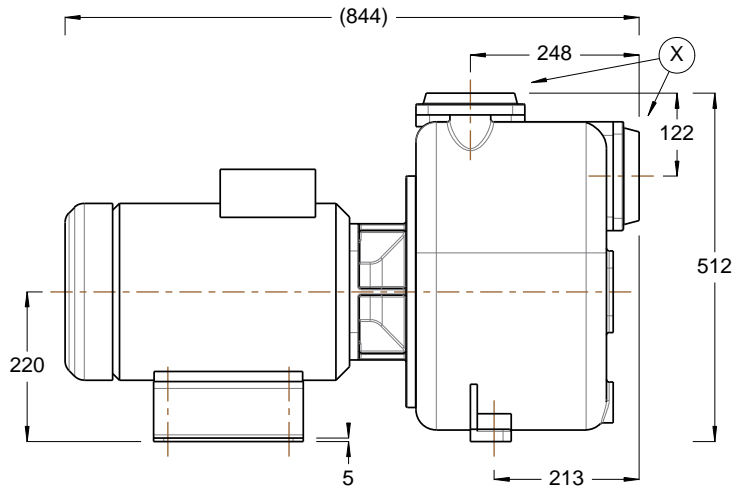
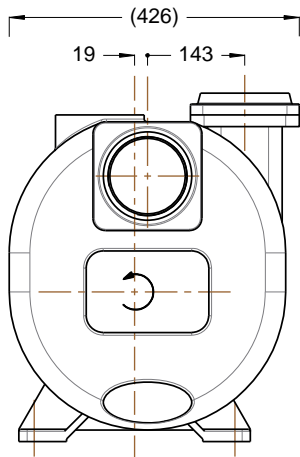

R4" BSP

