

S 100 ...T+F

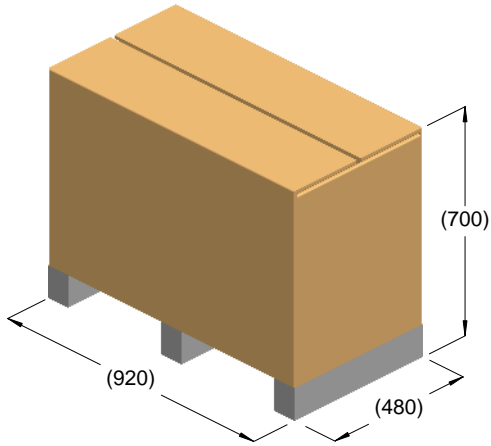

kg = 143
m³ = 0.31

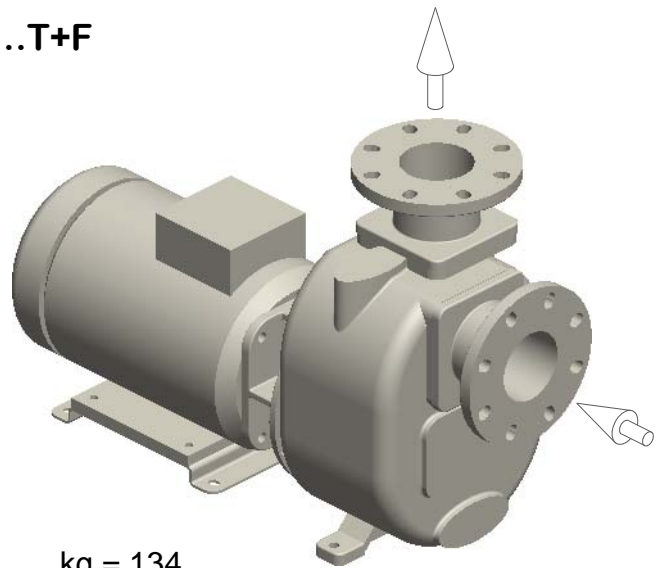

kg = 134

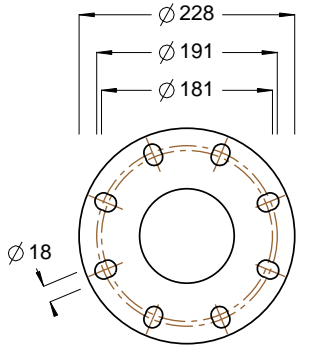
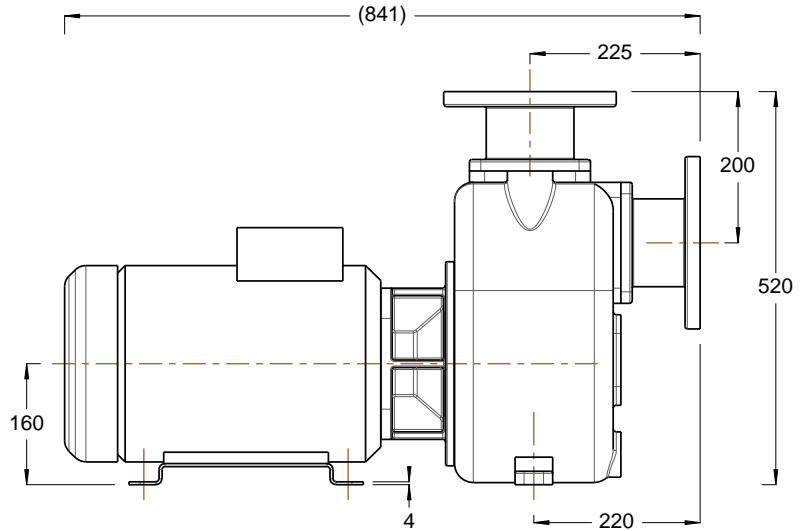
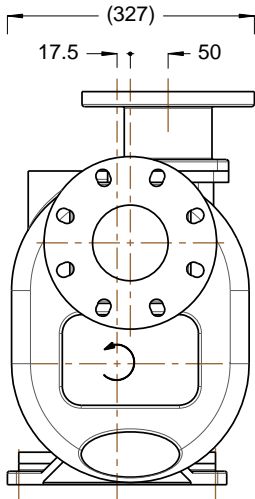

DN100 PN16 / ASA125 4"

