

S 88 K..B+F/T

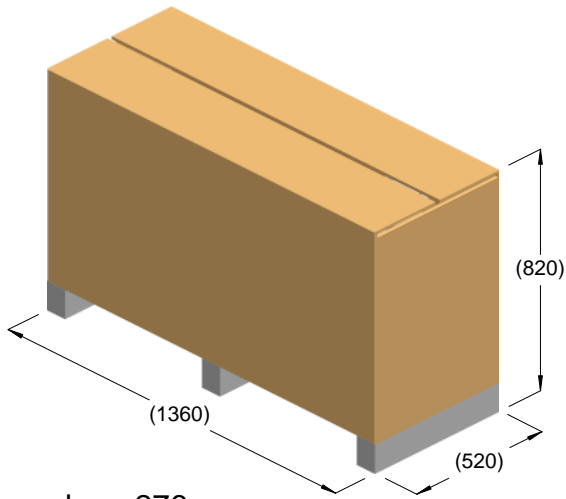

kg = 276
m³ = 0.58

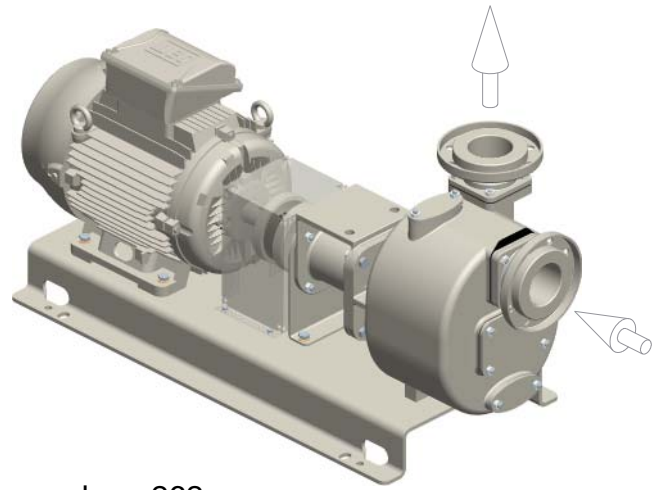

kg = 262

