

**S 88 ...B+F/T**

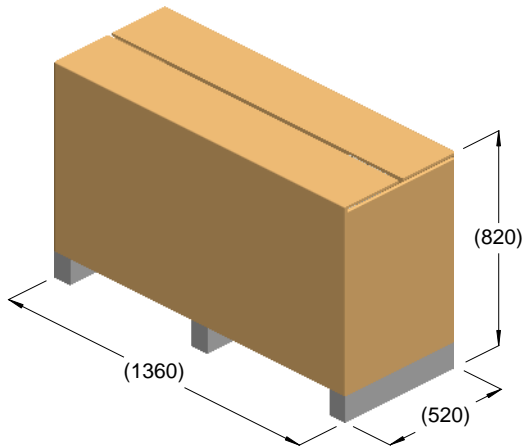

kg = 259  
m<sup>3</sup> = 0.58

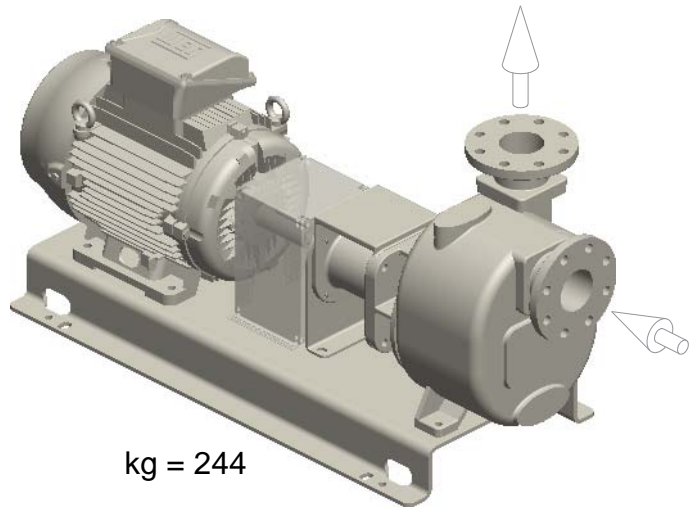

kg = 244

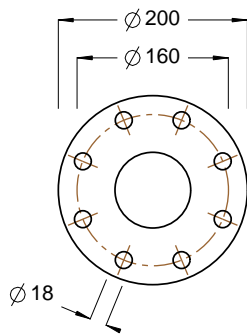
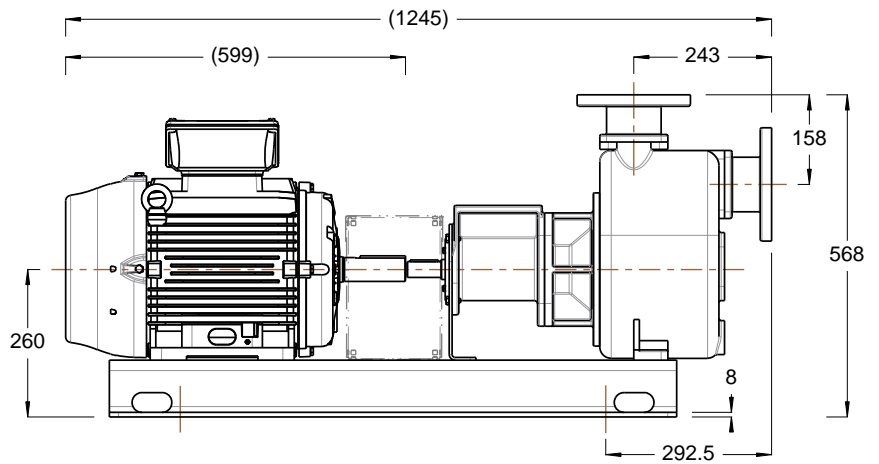
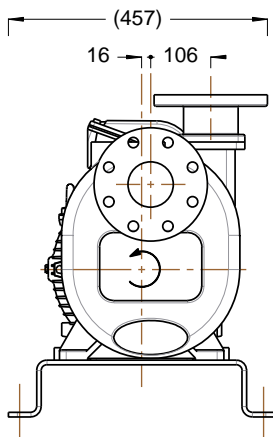

DN80 PN16

