

**S 88 ...B/T**

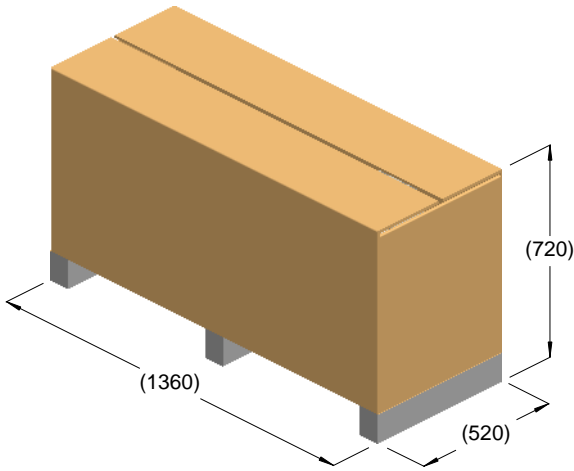

kg = 243  
m<sup>3</sup> = 0.51

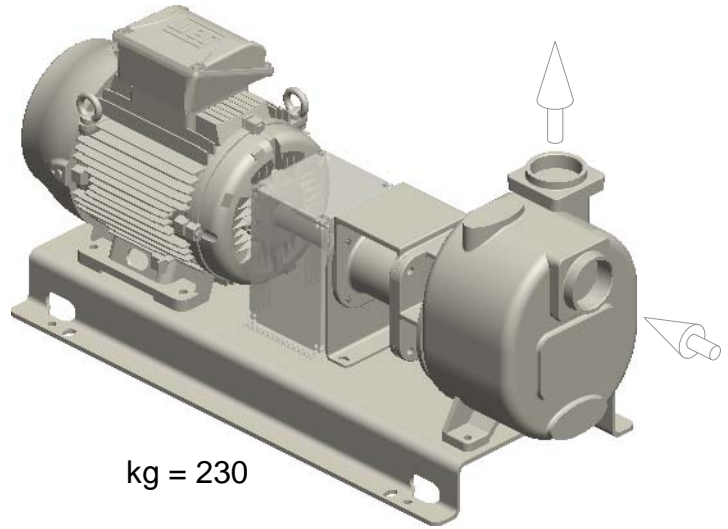

kg = 230

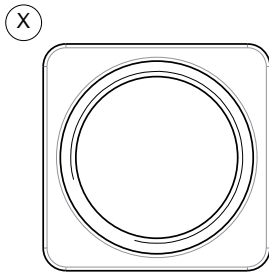
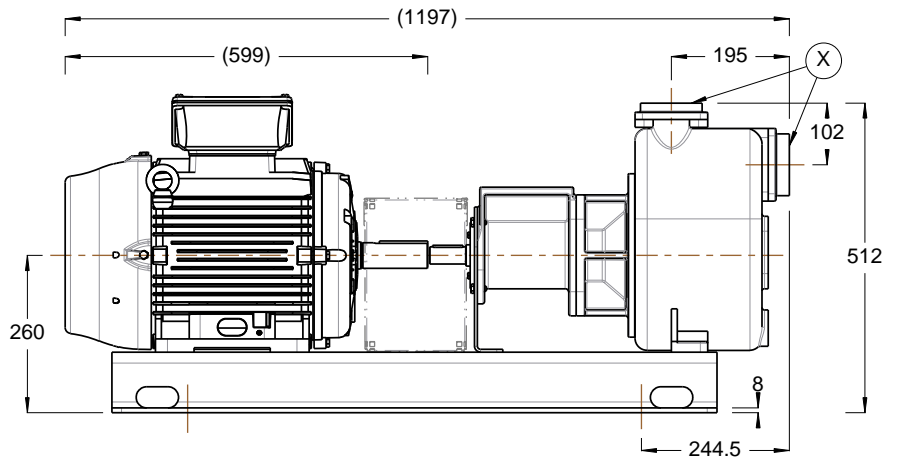
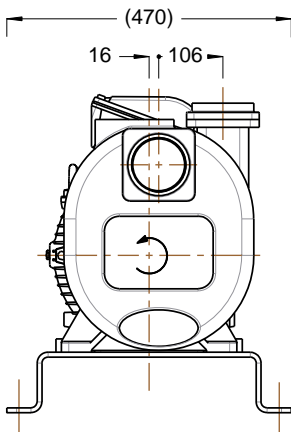

R3" BSP

