

S 85 ...B/T

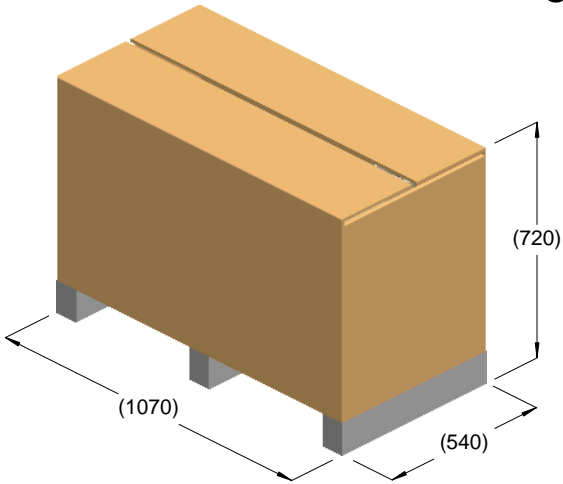

kg = 164
m³ = 0.42

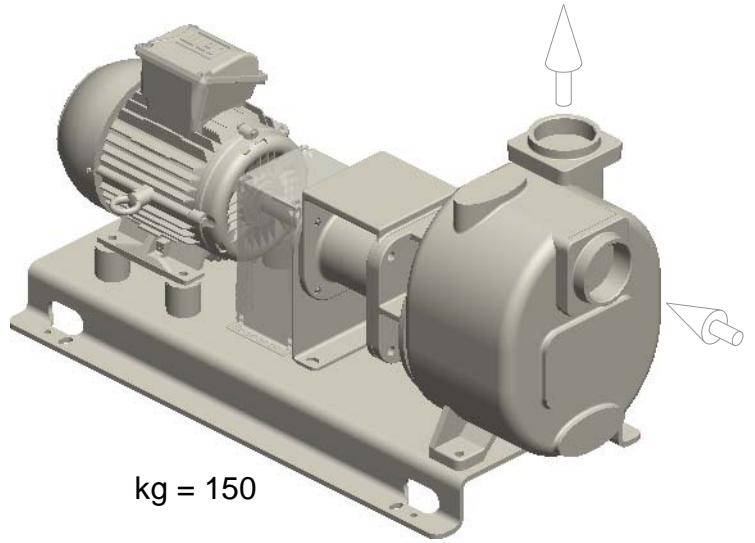

kg = 150

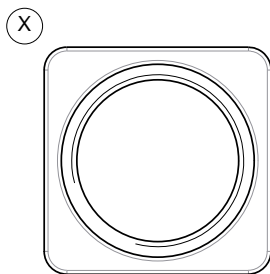
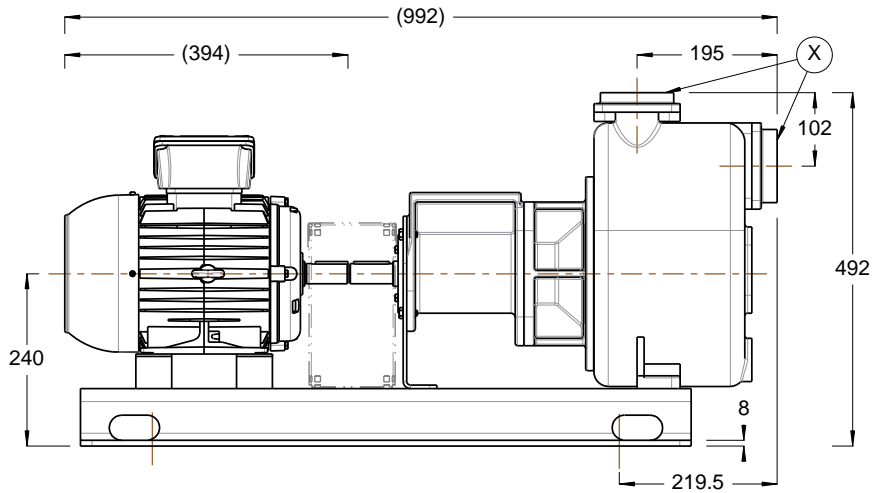
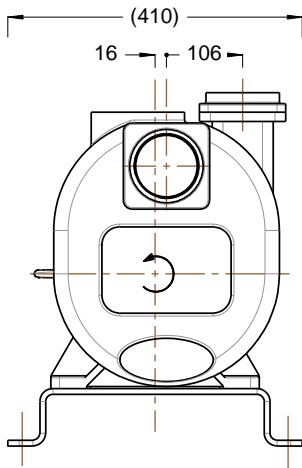

R3" BSP

