

S 83 ...B/T

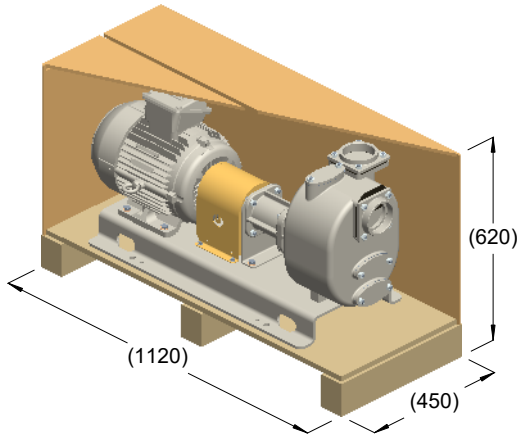

kg = 154
m³ = 0.31

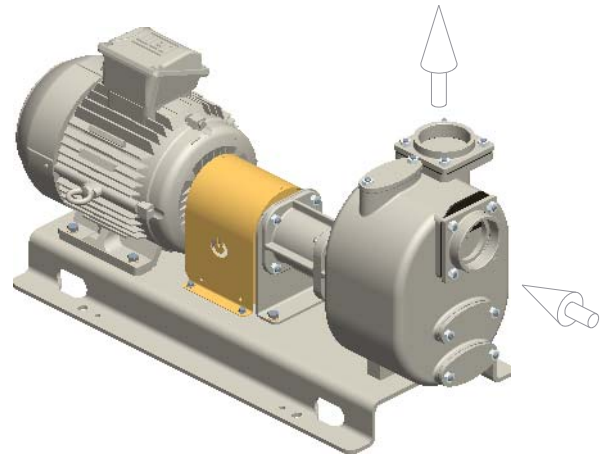

kg = 144

