

S 80 ...B/T

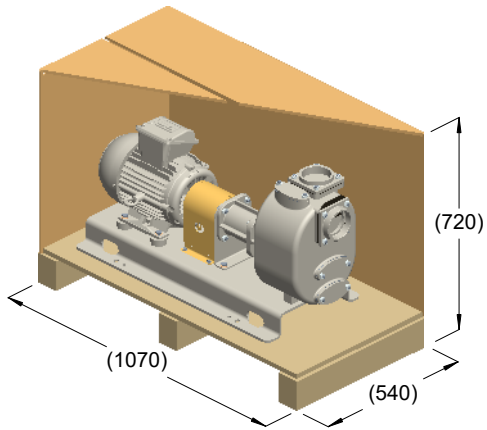

kg = 135
m³ = 0.42

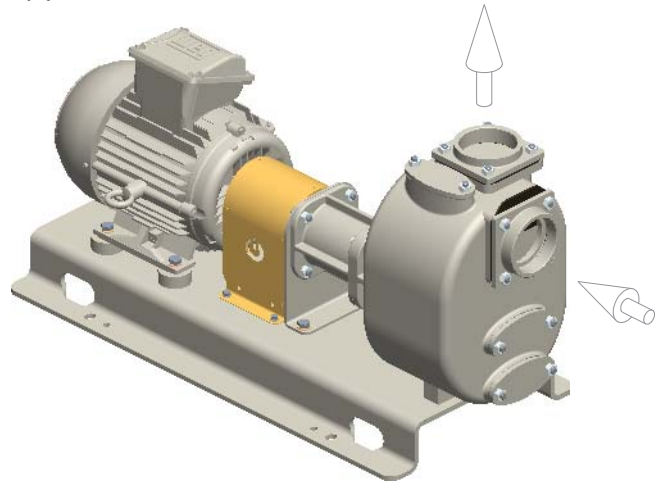

kg = 121

