

S 69 K..B+F/T

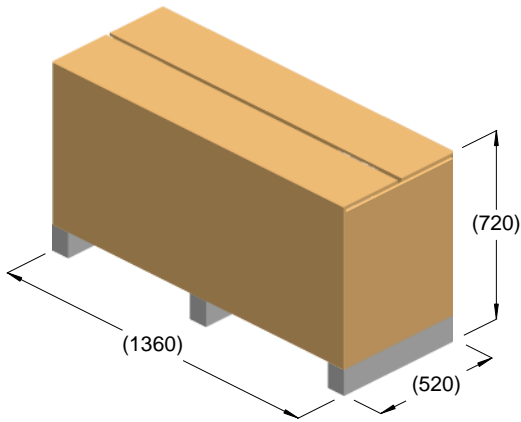

kg = 235
m³ = 0.51

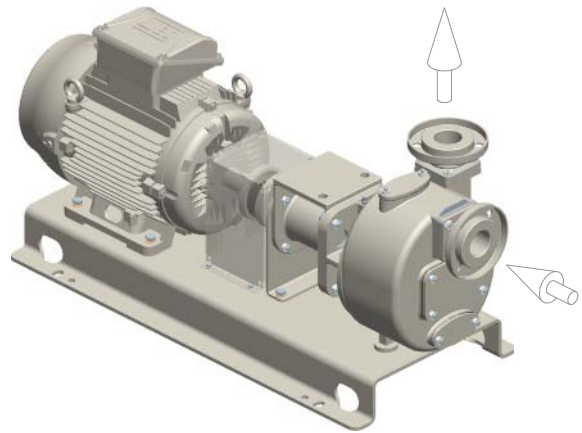

kg = 222

