

S 68 ...B+F/T

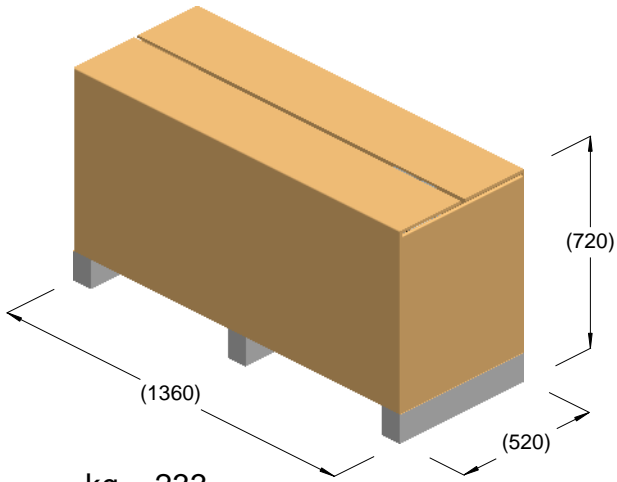

kg = 233
m³ = 0.51

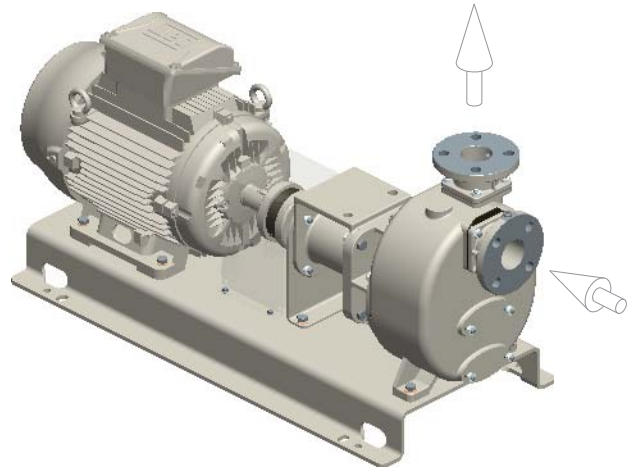

kg = 220

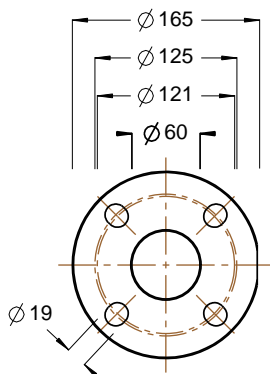
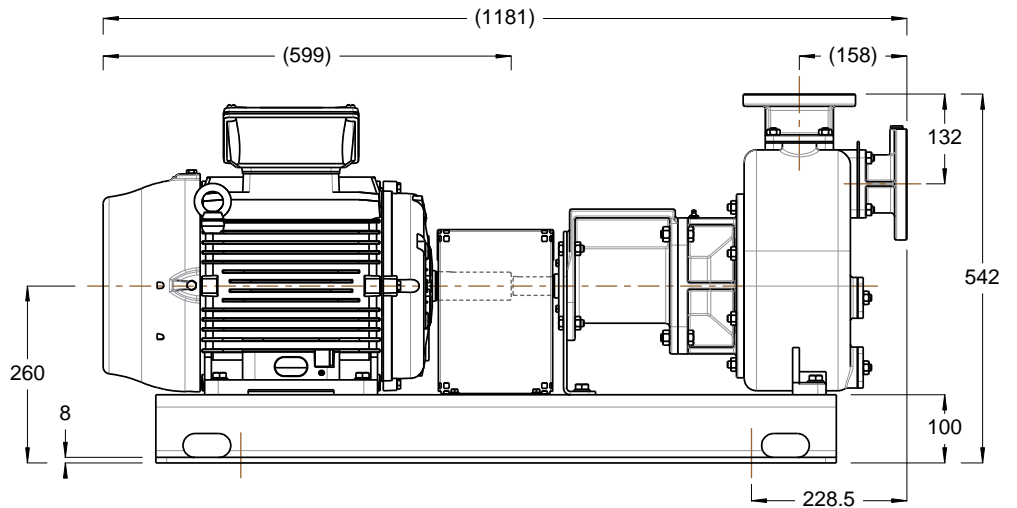
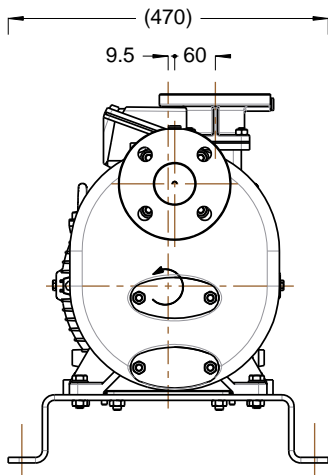

ISO DN50 PN16
ANSI 2" 125lb

