

S 65 ...B/T

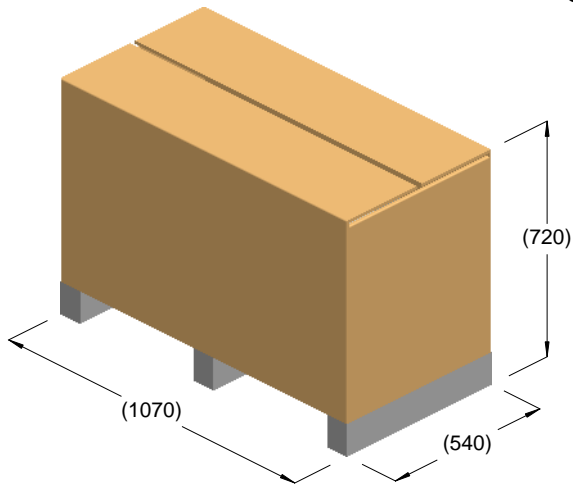

kg = 138
m³ = 0.42

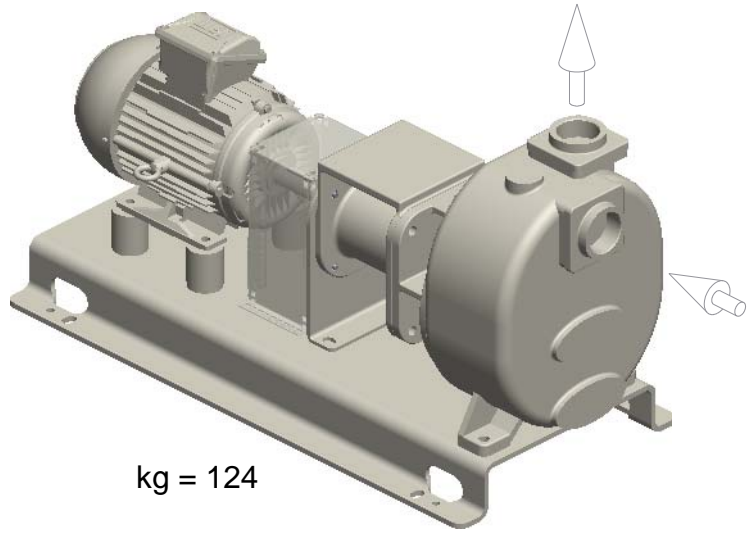

kg = 124

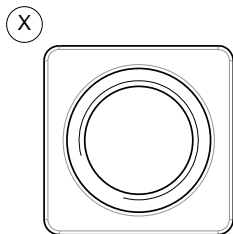
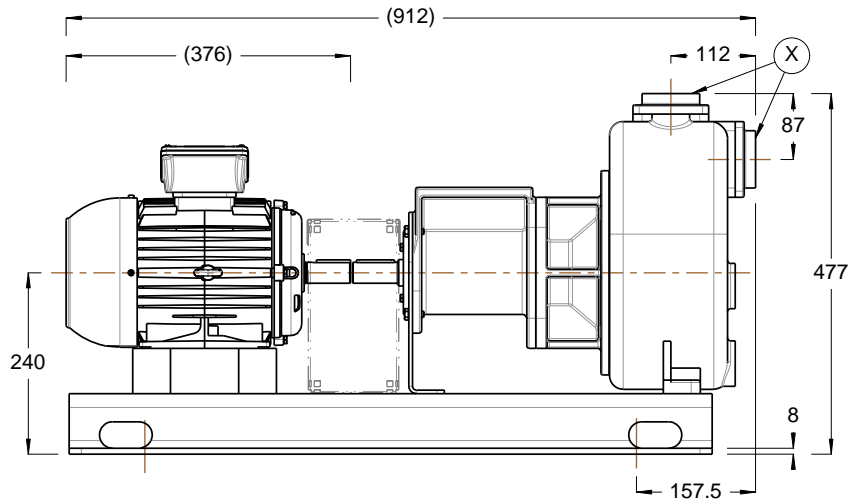
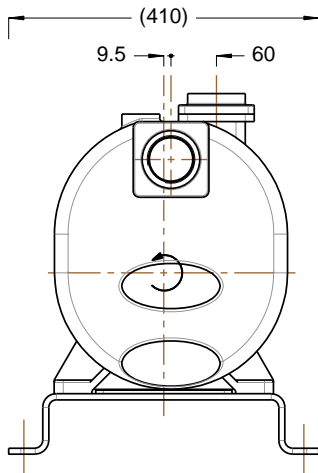

R2" BSP

