

**S 63 ...B+F/T**

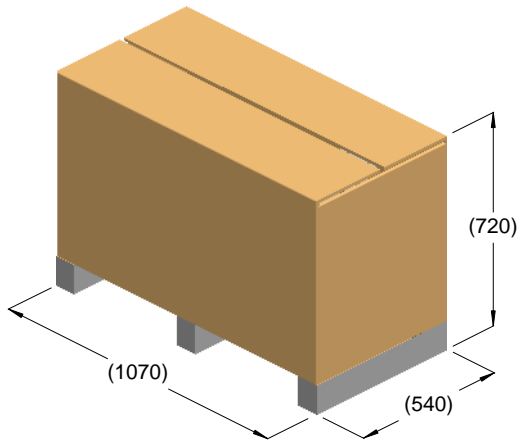

kg = 137  
m<sup>3</sup> = 0.42

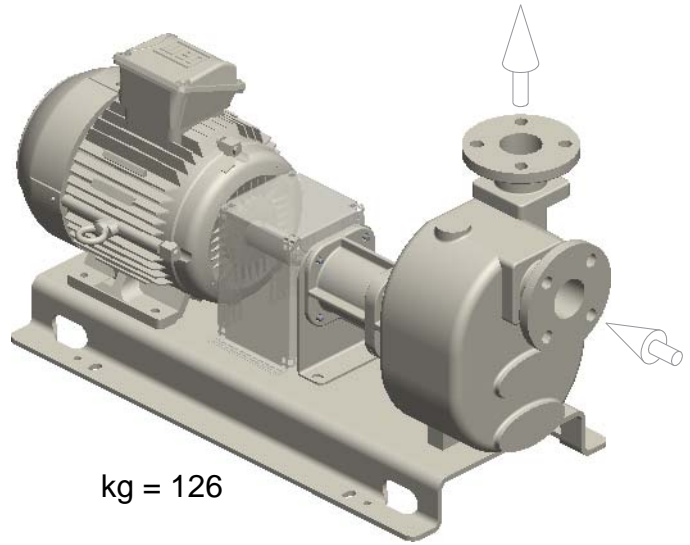

kg = 126

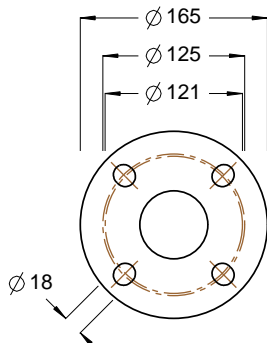
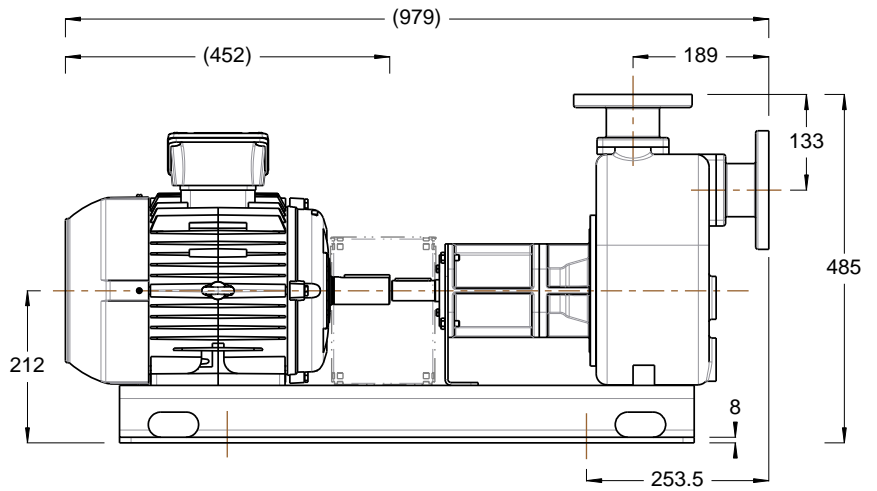
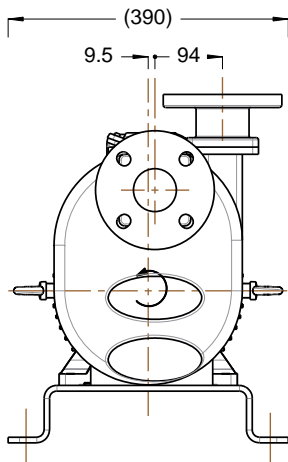

DN50 PN16 / ASA125 2"

