

S 63 ...B/T

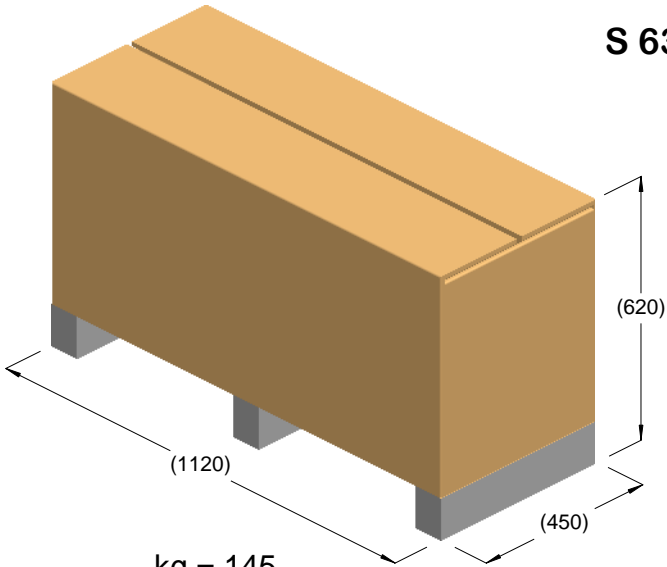

kg = 145
m³ = 0.31

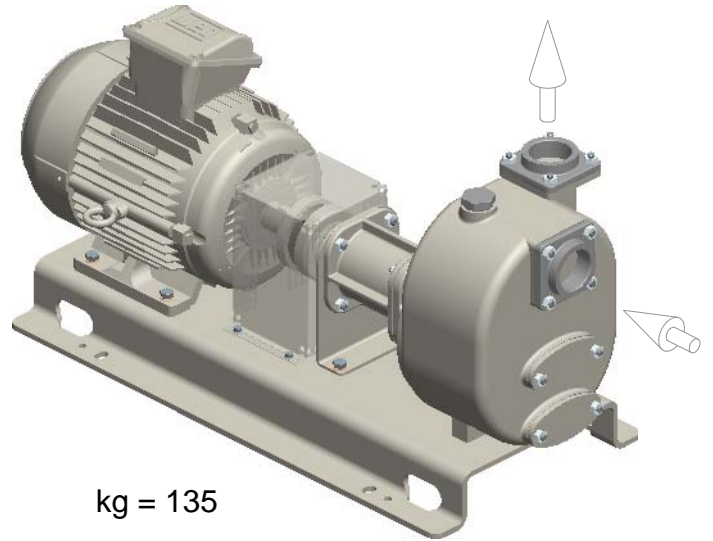

kg = 135

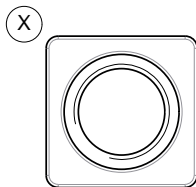
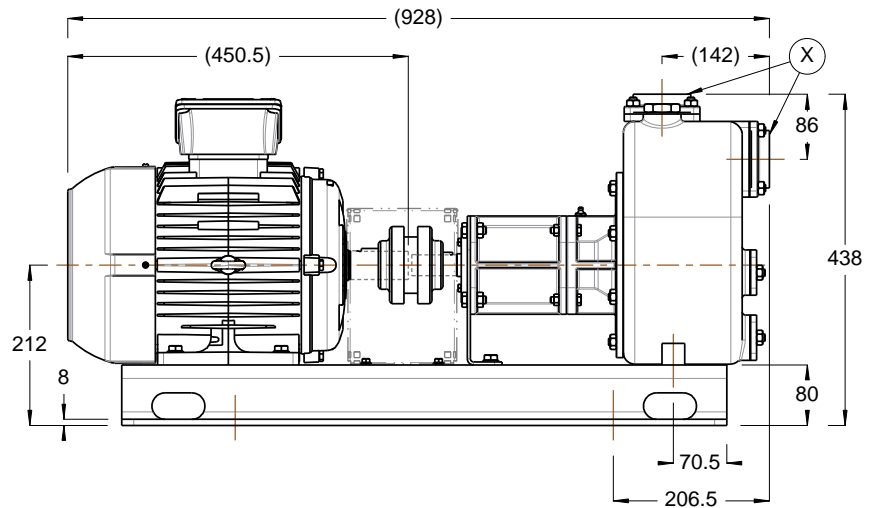
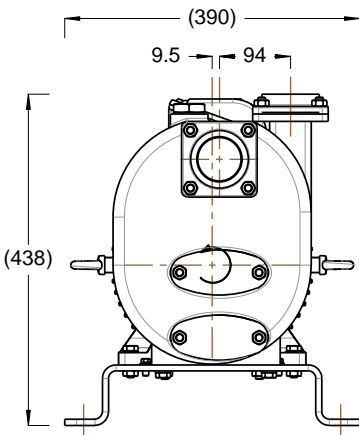

R2" BSP

