

S 60 ...B+F/T

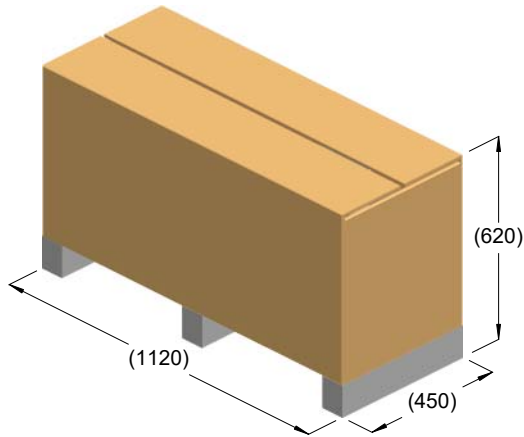

kg = 131
m³ = 0.31

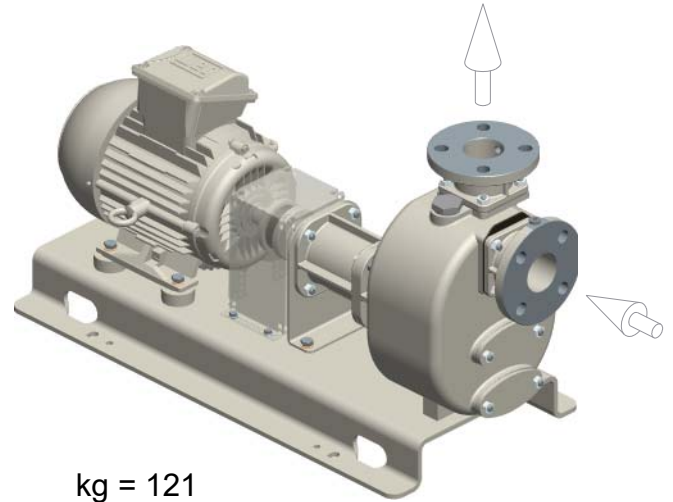

kg = 121

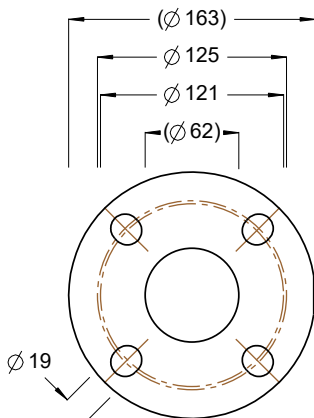
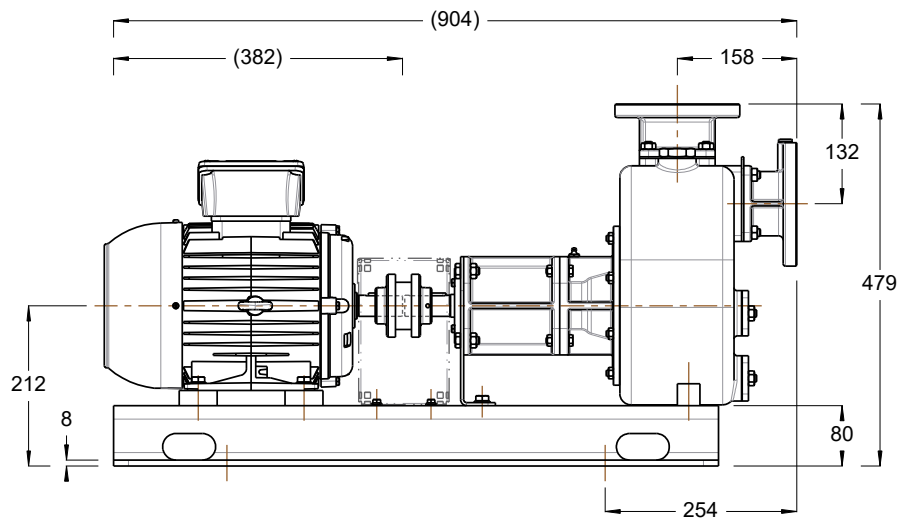
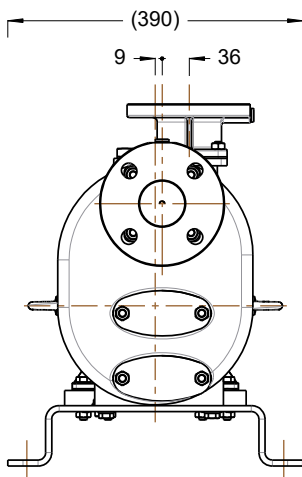

ISO DN50 PN16
ANSI 2" 125lb

