

S 60 ...B/T

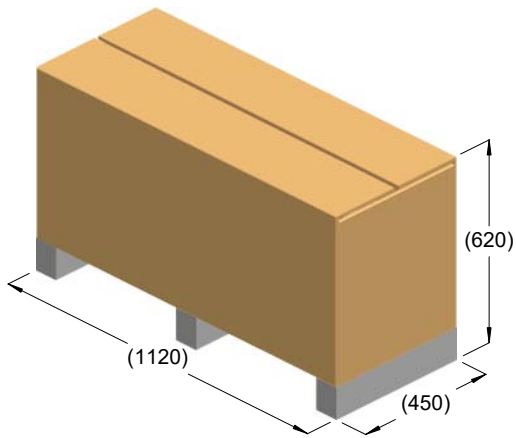

kg = 125
m³ = 0.31

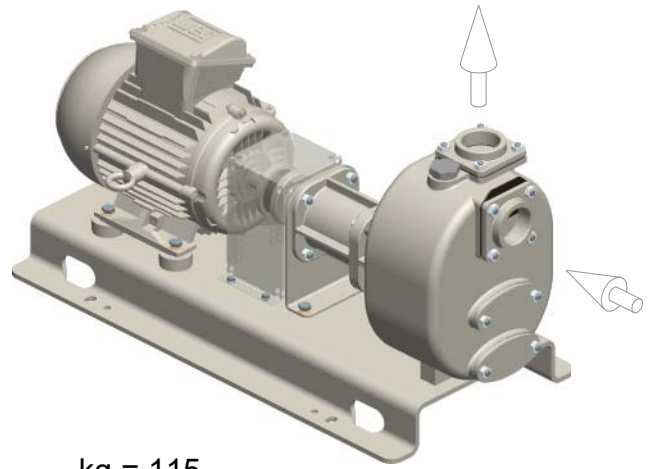

kg = 115

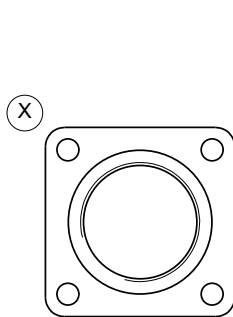
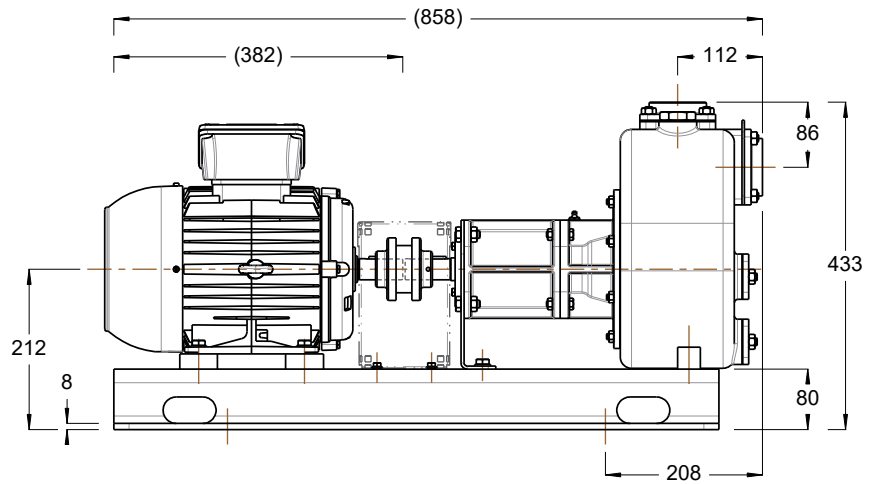
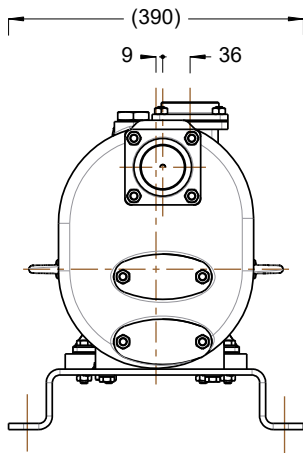

R2" BSP

