

S 51 K..S/T

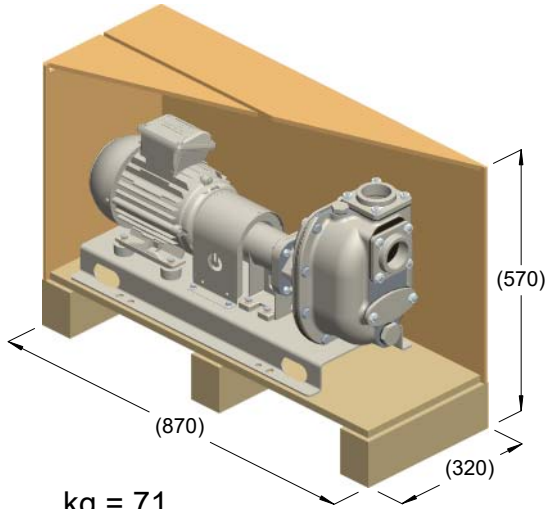

kg = 71
m³ = 0.16

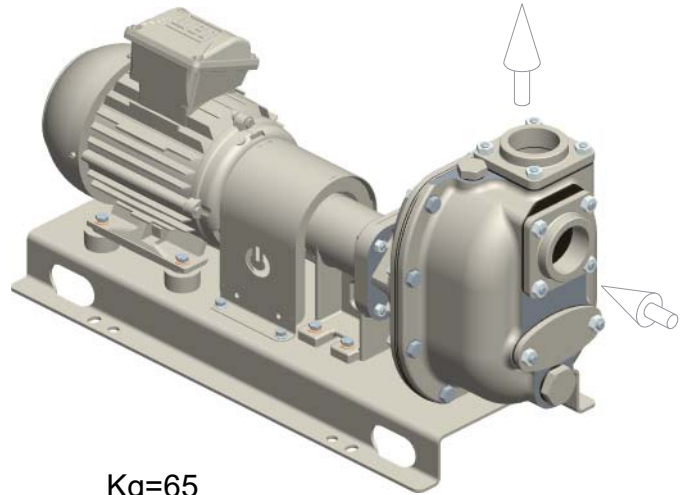

Kg=65

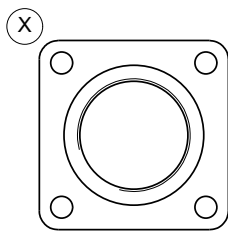
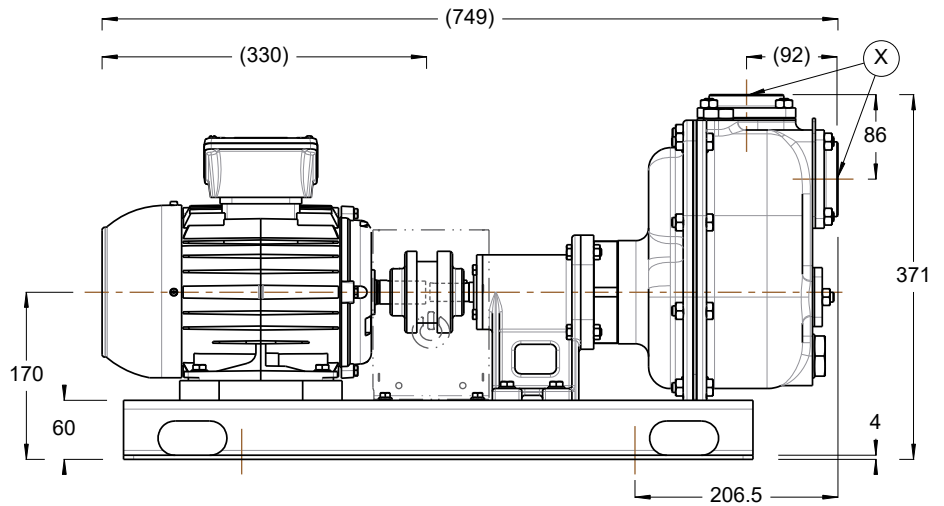
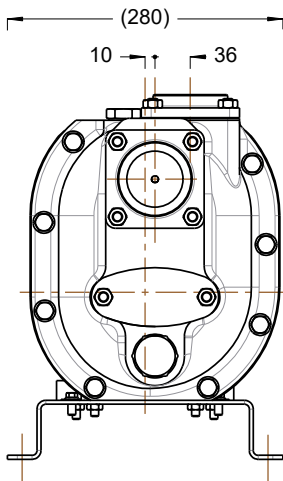

R2" BSP

