

**S 50 ...B+F/T**

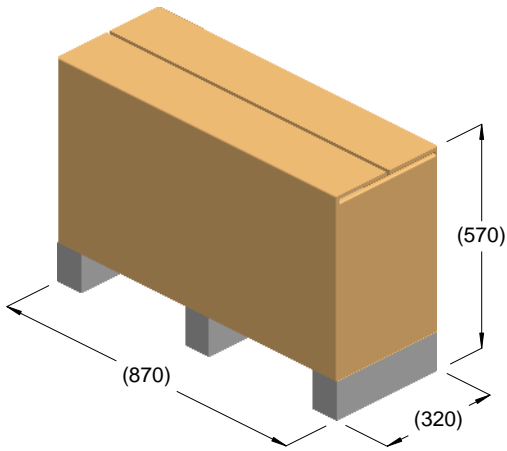

kg = 71  
m<sup>3</sup> = 0.16

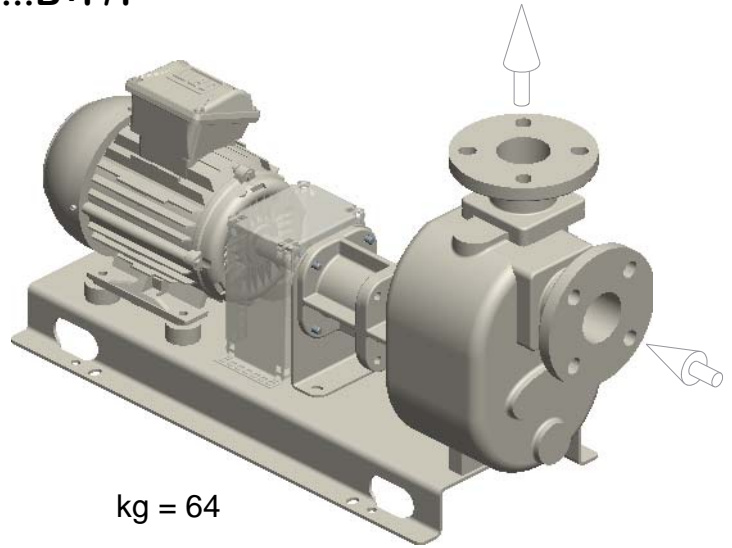

kg = 64

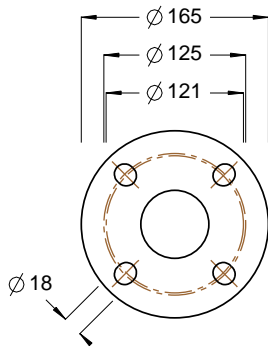
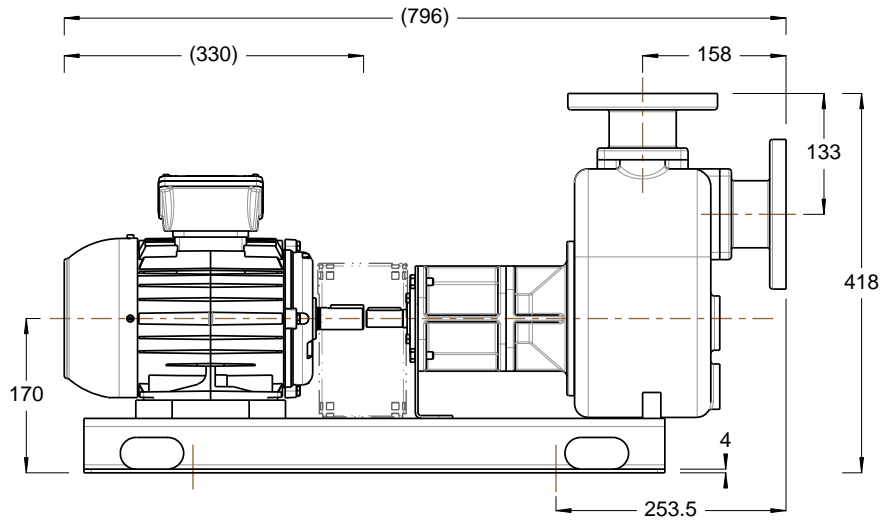
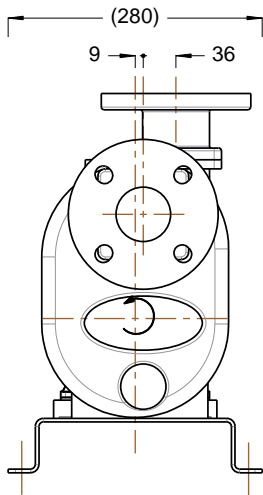

DN50 PN16 / ASA125 2"

