

S 50 ...B/T

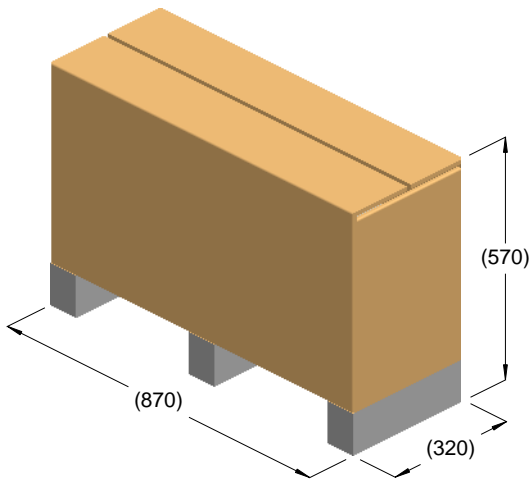

kg = 65
m³ = 0.16

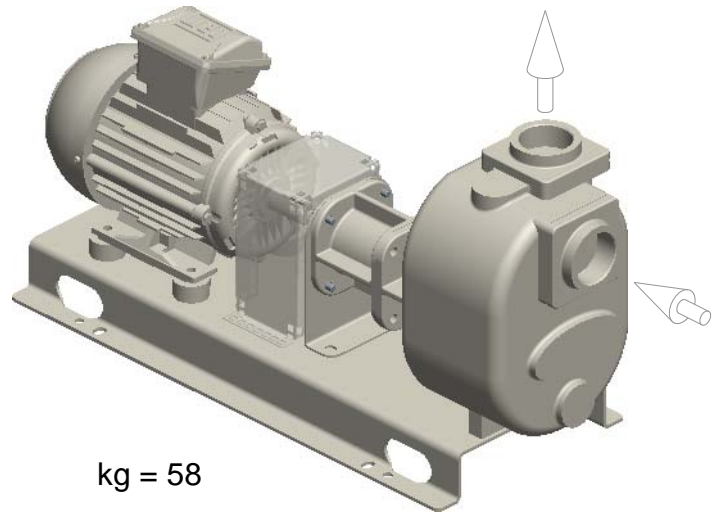

kg = 58

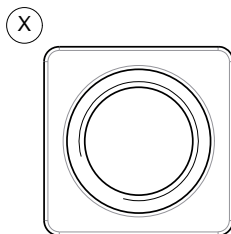
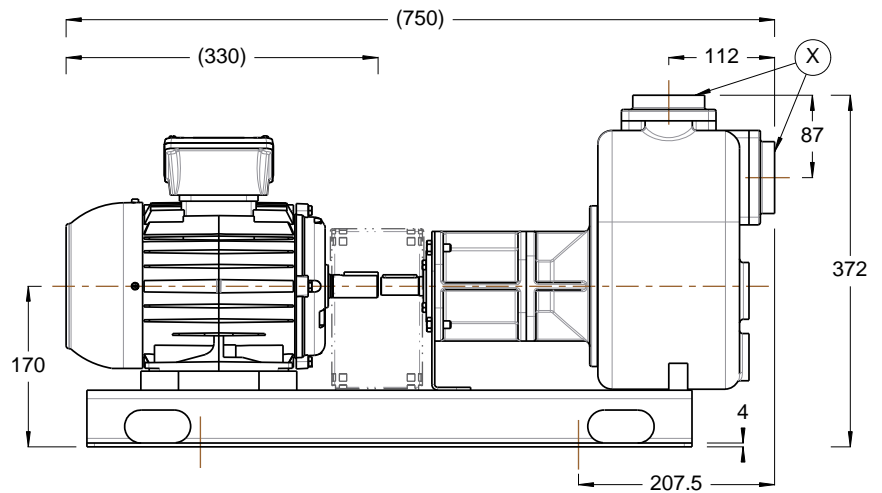
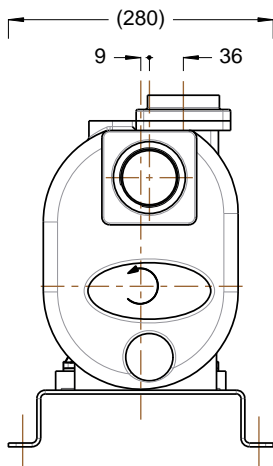

R2" BSP

