

S 45 ...B/T

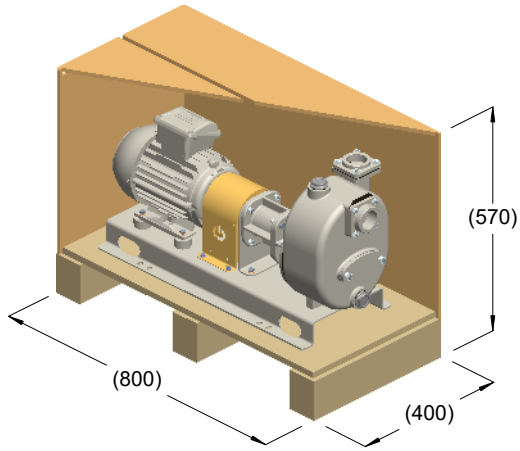

kg = 70
m³ = 0.18

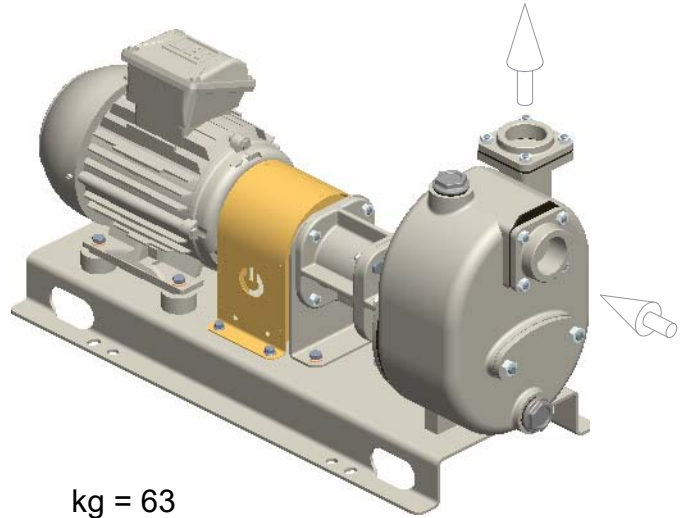

kg = 63

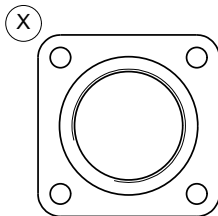
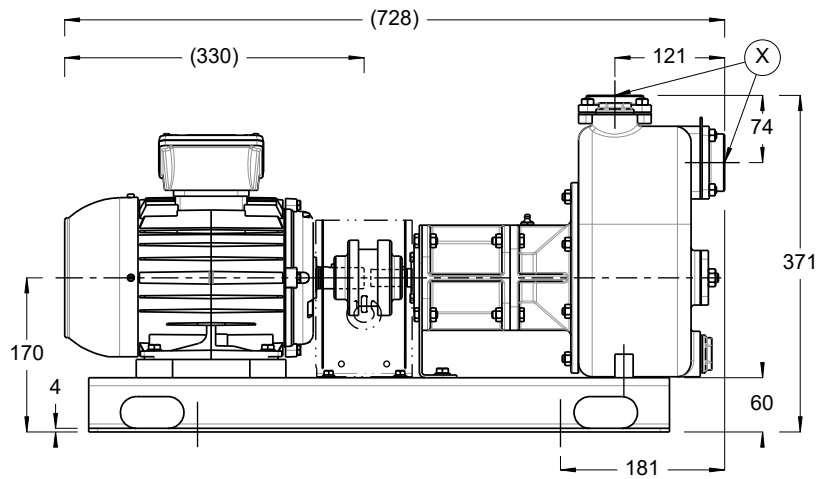
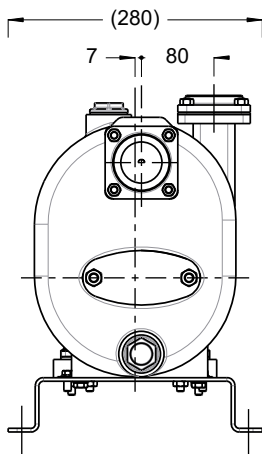

R 1½" BSP

