

S 40 ...B+F/T

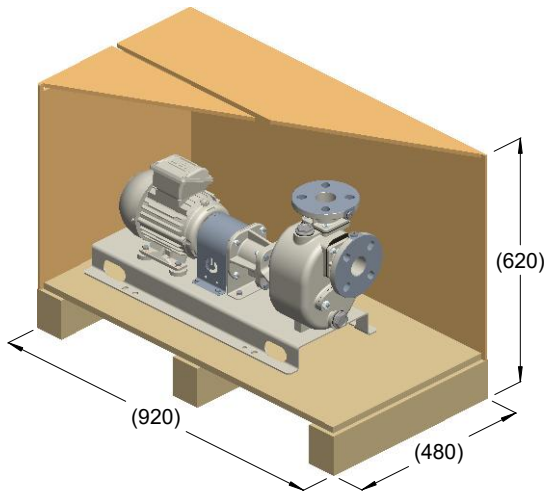

kg = 43
m³ = 0.27

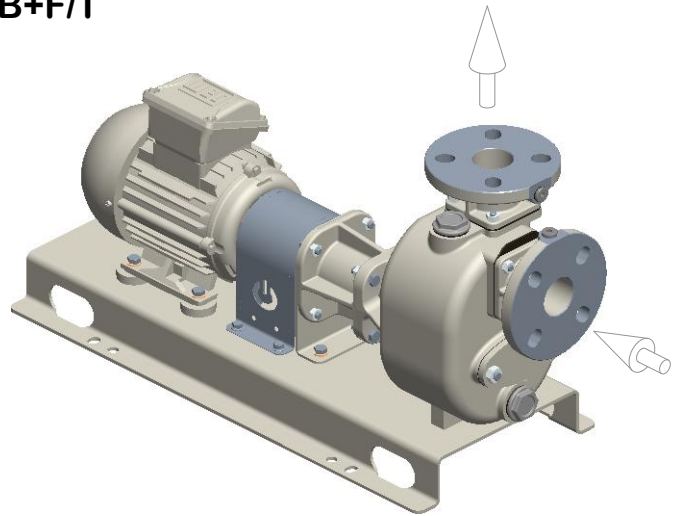

kg = 35

