

S230 ...B+F/T

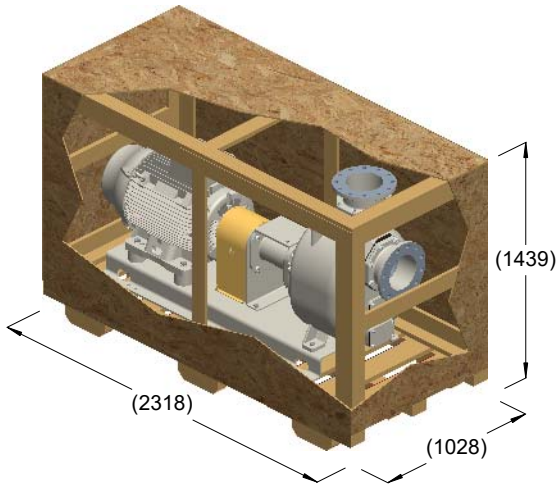

kg = 937
m³ = 3.43

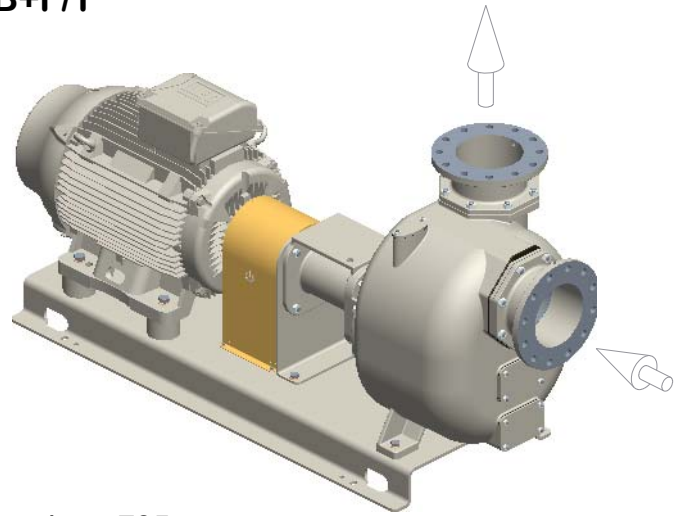

kg = 785

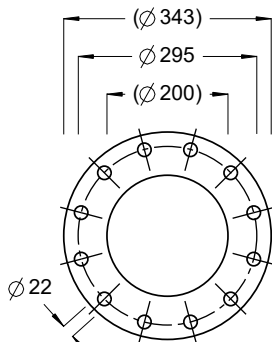
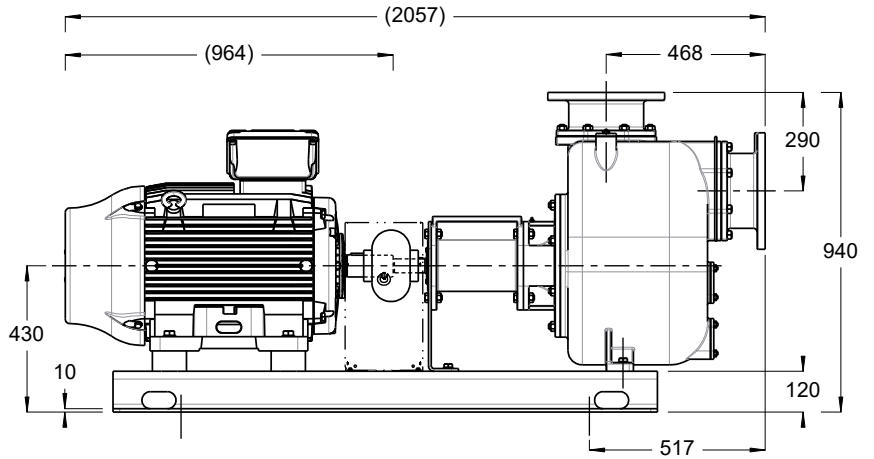
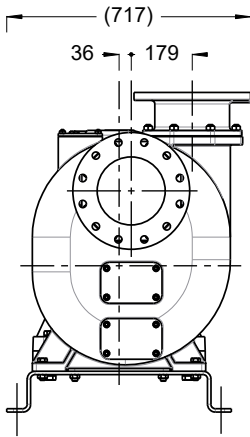

ISO DN200 PN16
ANSI 8" 125lb

